

LK CubicSecure – An intelligent water safety system

DESIGN

LK CubicSecure is a water safety system that protects against leakage by continuously measuring water consumption, water pressure and temperature. The unit emits alarms for both micro-leaks and larger leaks. When the water safety system detects a leak, it automatically shuts off the water flow. The water circuit breaker can be installed in villas, terraced houses and apartments (1).

SYSTEM DESCRIPTION

LK CubicSecure is a small unit that is easy to install in confined spaces. The unit is easily installed on incoming water pipes for a house or apartment. The water safety system is equipped with a switch for manual shut-off in the event of power failure or emergency.



NOTE!

Two water safety systems can be paired in order to avoid scalding in apartments. Pairing provides a synchronised automatic shut-off between the hot and cold water pipes.

With the MyLK app and Wifi connectivity, you can remotely control the unit to shut the water off or on, acknowledge alarms and monitor your water consumption, for example.



MyLK app.



QR code to MyLK app.



LK CubicSecure.

TABLE OF CONTENTS





Design	1
System description	1
Preparing for installation	2
Installation	2
Startup	3
Pairing	3
Functions	4
Summary of LEDs	4
Start-up and function check	5
Operation	6
Maintenance	6
Technical data	7
Comment	7
Environment	7
Guarantee	7
CE approval	7

PREPARING FOR INSTALLATION

The water safety system must be installed by a plumber according to the Safe Water Installation industry regulations.

The water circuit breaker must be installed in a location that is easily accessible for service and maintenance.

TIP! The water safety system is equipped with a G20 EuroCone external thread which is to be installed with an LK PressPex press connection coupling or LK Pushfit AX connection coupling. When using a flat gasket, LK Plain Adapter is supplied (RKS-187 06 78) with the product.

	<p>NOTE! Safety systems such as residential sprinklers and emergency cooling of solid fuel boilers or similar must be connected before the water safety system. If they are installed afterwards, they risk being left without a water supply.</p>
	<p>NOTE! Install the water safety system after supplying safety systems that require water.</p>
	<p>NOTE! Water filters that are backwashed should be connected first so that their function is not disturbed. The system prevents water damage that can occur after the location of the CubicSecure.</p>
	<p>NOTE! When installing metal pipes in the distributor cabinet, the pipe must be provided with an electrical protective equalization (earthing) which must be installed by a qualified electrician unless the earth screw is already in the cabinet.</p>

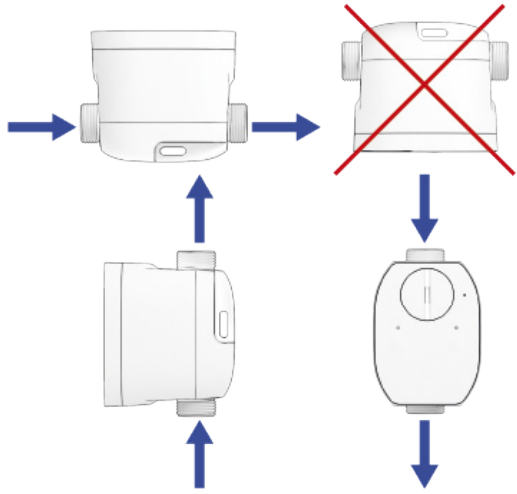

Correct installation of the water safety system. The arrows show the direction of water flow.

INSTALLATION

1. Install the water safety system on the incoming water pipe directly after the water meter isolation valve and any check valve.
2. Tighten the couplings without damaging the plastic casing on the water safety system.



The water safety system and the incoming water pipe.

TIP! The water safety system is equipped with a counterhold on the underside. Use an adjustable wrench on the counterhold. It is also possible to use a screwdriver in the slot to create a counterhold.

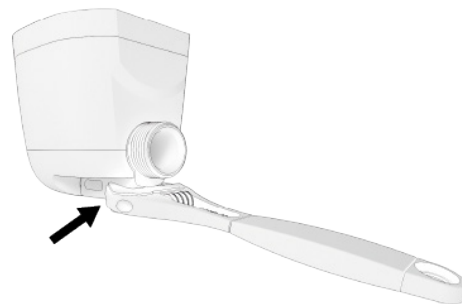

The counterhold on the underside of the water safety system.

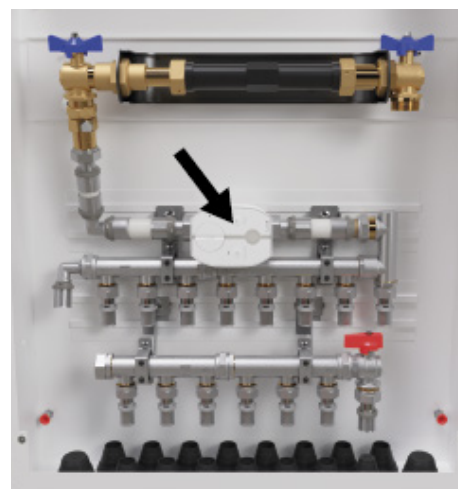

The water safety system installed in the cabinet.



STARTUP

1. Connect power to the unit using the micro-USB power adapter included.

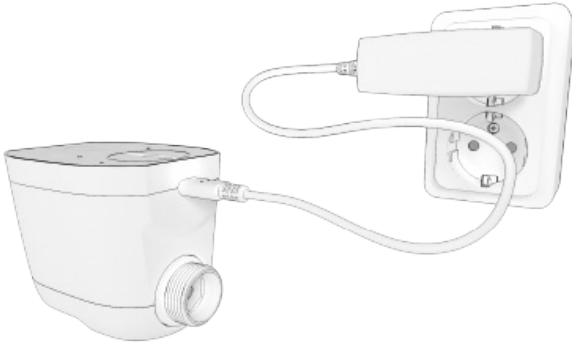

The water safety system connected to the power source.

2. Check that the STATUS LED is WHITE.
White light indicates that the device is operating normally when CubicSecure is installed on a water-filled pipe. If not installed on a pipe filled with water, the unit will not glow WHITE. If no LEDs light up, check that the wall outlet or power adapter is functional.

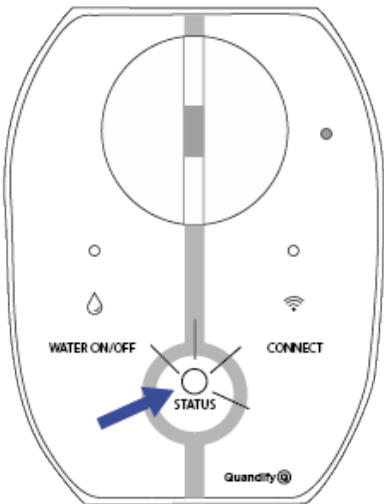

White light - the unit is working normally.

Connecting to Wifi (1)

Remote monitoring of the unit's measurements and alarms via a smartphone requires an app and a connection to a Wifi network with a frequency of 2.4 Ghz.

1. Download and install MyLK-app from App Store or Google Play Store.
2. Start MyLK-app and log into the app.
3. Follow the instructions in MyLK-app.

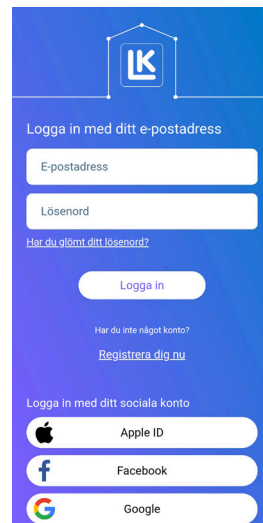

The login page for the MyLK app.

PAIRING

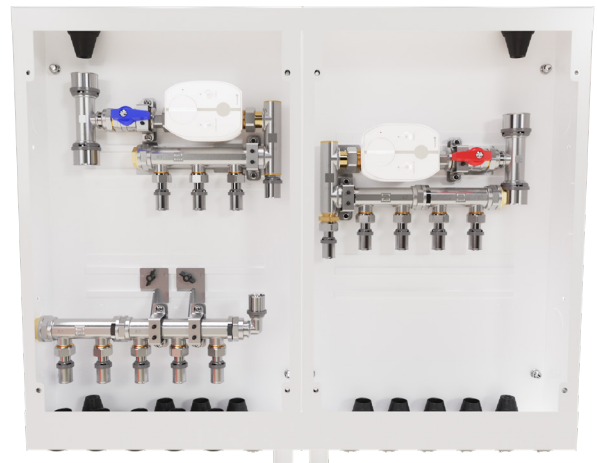

Example cabinet with pairing.



Manual pairing

1. Install and start the units. One for hot water and one for cold water.
2. Hold down the CONNECT button for five seconds on the unit installed for cold water. The CONNECT LED starts flashing YELLOW and BLUE.
3. Hold down the CONNECT button for five seconds on the unit installed for hot water. The CONNECT LED starts flashing YELLOW and RED.
4. Make sure that the CONNECT LEDs on both units flash GREEN rapidly for about a second.
5. If pairing was not completed, redo process steps 2 to 4.



NOTE!

In the event of apartment installation, units should be installed on hot and cold water pipes to protect against any leakage and avoid possible scalding.

FUNCTIONS

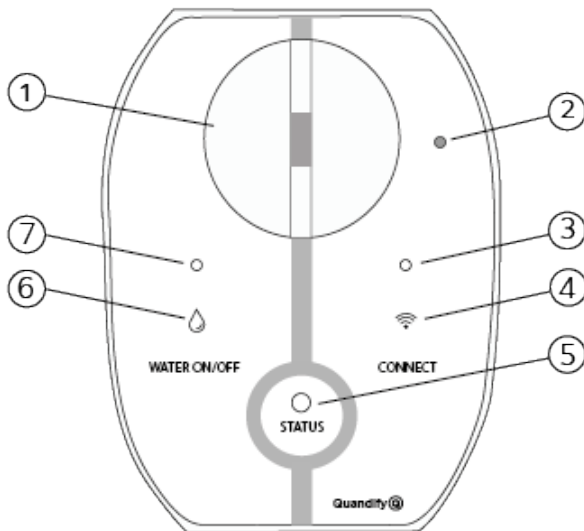

1. Valve switch.
2. Reset button (factory setting)
3. CONNECT LED for pairing.
4. CONNECT button for pairing.
5. STATUS LED (red, green, white and yellow).
6. ON/OFF button for water.
7. ON/OFF LED for water.

Power failure/Restart

After a power failure, the device returns to the same mode it was in before the power failure.







SUMMARY OF LEDs

STATUS LED		Meaning
WHITE		The unit is switched on and active, and no errors or alarms are indicated.
Dark/Off		The unit is not powered. Make sure the unit is connected to a power source. Check that the power source is working properly.
YELLOW		Leak detection is deactivated. Press the WATER ON/OFF button to activate the function.
YELLOW Flashing		Detected leakage.
WHITE Flashing		The unit is being updated and other functions are temporarily disabled. Do not disconnect the power source.
GREEN Flashing		The unit is collecting data on the water pressure and has closed the valve in the meantime. Data collection continues for up to one minute, after which the unit opens the valve again.
RED		The unit is not working/is not working properly. Contact technical support.

WATER ON/OFF LED		Meaning
WHITE		The valve is open. The water supply/flow is on.
Dark/Off		The valve is closed. The water supply/flow is off.
WHITE Flashing		Indicates that there is an ongoing water flow.
YELLOW		The leak detection is either deactivated or the water pressure is below 0.5 bar. Press the WATER ON/OFF button to activate the function.

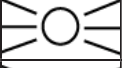
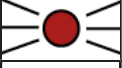

WATER ON/ OFF LED		Meaning
RED		The water pressure is very low or there is no water in the pipe. Check that the water system is working properly.

CONNECT LED		Meaning
WHITE		Wifi configured and connected.
Dark/Off		Wifi not configured.
WHITE Flashing		The unit is in hotspot mode for Wifi configuration.
RED Flashing		No Internet contact with the Wifi network.
YELLOW Flashing		Ongoing pairing establishment between two water safety system units, one for cold water and one for hot water.
YELLOW/ BLUE Flashing		Pairing completed between the hot and cold water units. The connection is made from the cold water unit which flashes YELLOW/BLUE.
YELLOW/ RED Flashing		Pairing completed between the hot and cold water units. The connection is made from the hot water unit which flashes YELLOW/RED.
GREEN Flashing		Pairing has been successful and is completed.

START-UP AND FUNCTION CHECK

Check that the ball valve is working

1. Press the WATER ON/OFF button.
The LED stops lighting when the ball valve has completely shut off the water flow.
2. Open a tap. Check that no water comes out of the tap.
3. Press the WATER ON/OFF button.
The LED shines with a white light when the valve is fully open. Check that water is now coming out of the open tap. During active waterflow the LED flashes white.

Check that the pressure sensor is working

1. Open a tap to simulate a very small leak. A dripping stream of water will suffice.
2. Press the WATER ON/OFF button to close the valve.
 - When the valve is closed, the STATUS LED will flash GREEN while the pressure sensor scans for small leaks for about 45 seconds.
 - If the pressure sensor manages to find a leak, the STATUS LED starts flashing YELLOW. If the pressure sensor does not find a leak, redo the steps with a slightly larger leak.
3. Close the tap and press the WATER ON/OFF button to open the valve again.

Leakage control with flow

1. Open a tap with the valve in the open position.
2. Leave the valve at full flow on the tap for at least 45 minutes.
3. Check that the unit emits an alarm and switches off the flow after 45 minutes.
4. Then close the tap and reset the unit.



Alarm

Micro leakage

- A micro leakage is detected by the valve being automatically closed daily to measure a pressure drop above 0.5 bar for a maximum of 45 seconds.

Medium-sized leakage

- The unit alarms and shuts off the water after a continuous flow for at least 45 minutes.

Large leakage

- The device alarms and closes the valve after a continuous flow over 1500 l/h for at least 90 seconds.

Acknowledge alarms

- Press the WATER ON/OFF button once to acknowledge the alarm.
- Press the WATER ON/OFF button again to open the valve.

Note that an acknowledgment resets all ongoing leak detections.

Reset WiFi settings

1. Restart the device using the power cable and press the CONNECT button once before the LED lights up with a solid white light.

Factory reset of the unit

1. Unplug the power cord if it is in the unit.
2. Insert a paper clip into the hole above the right LED for 3 seconds while plugging in the power cable. The right LED will first glow red and then turn off.
3. Wait for about three minutes while the device resets. During this time, the start LED on the left side and the lower LED, which marks the status, light up. The right LED will not illuminate.
4. Launch the MyLK app and start setting up the device.

OPERATION

Follow the unit's measurements via the MyLK app(1). Various data such as temperature, volume, water pressure, valve position and no leakage detected are displayed for each unit. When LK CubicSecure is in operation, it performs automatic leakage tests and exercise the valve. If a fault occurs during operation, the unit will emit an alarm and close the valve.

Use of large amounts of water

The abnormal flow alarm function can be deactivated if a larger amount of water is needed to fill a pool or for irrigation. The preset time is 24 hours. The deactivation of the alarm can be done in the MyLK app or manually.

Manual

1. To deactivate the alarm function, press and hold down the Water ON/OFF button for at least five seconds.

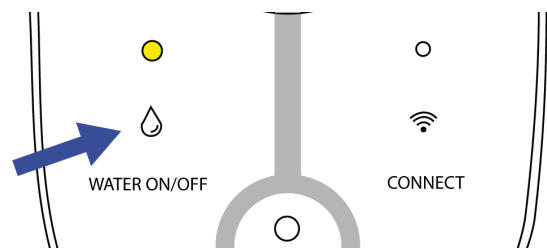

WATER ON/OFF button and yellow LED for the function.

MAINTENANCE

Check the opening and closing function of the valve

1. Press the WATER ON/OFF button.
 - The button shines WHITE when the valve is open.
 - The LED is off and dark when the valve is closed.
 - The switch at the top of the unit must rotate and break the line when closed and follow the line when open.

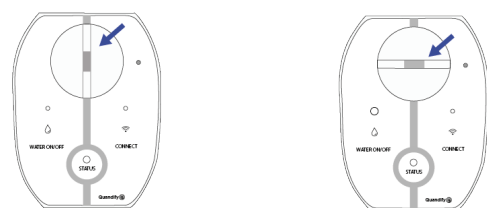

The picture on the left shows an open valve, a closed valve is shown on the right.



TECHNICAL DATA

Area of use	Villa, terraced house, apartment
Water temperature	0,1-70 °C
Pressure	PN10
Maximum pressure during tests	16 bar
KVS	4,6 m³/h
Environment	Indoors
Climate/Environment	5 °C ... 30 °C
Storage	-25 °C ... 55 °C, dry environment
Wireless frequency	2.4 GHz
Nominal flow rate (Q3)	4,000 l/h
Start, flow	6 l/h
Micro-leakage detected	>0.5 bar pressure loss.
Mid-sized leakage detected.	>6 l/h for at least 45 minutes
Leakage detected, large	>1500 l/h for at least 90 seconds
Weight	720 grams
Dimensions	85 mm height: 71 mm width, length 110 mm

Contents of the package

- CubicSecure 1 piece, LK RSK - 188 26 67
- Mains Adapter 1 piece
- Plane Adapter 2 pieces. LK RSK-1870678. Accessories that simplify installation of LK pipes.

COMMENT

Completely interference-free operation cannot always be guaranteed with the technology available today, which allows free use of the frequency band.

Every installation should therefore be tested individually. LK CubicSecure always works independently. The water safety system will still work if the unit loses contact with the Internet. The unit is still in operation and emits an alarm when a leak is detected. The contact with the MyLK app is temporarily interrupted, and it then does not receive notifications or alarms until contact is established with the Internet

ENVIRONMENT

LK Systems is affiliated with El-Kretsen for collecting and recycling electronics and batteries. Used batteries should be sorted as batteries or small batteries and deposited for battery recycling. When the system has reached the end of its life, it should be sorted as electronics or other electronics and deposited with a recycling centre.

GUARANTEE

LK Systems AB is responsible for faults in products that appear within two years from the delivery of the product to the buyer. If LK is responsible for the fault in the product, LK has the right to replace the product with either a new or repaired product. The liability period for replacement or repair of a product or spare part does not exceed the liability period for the original product. The seller is not responsible for faults resulting from accidents, incorrect installation, incorrect installation, incorrect care, abuse or other irregular use. LK Systems AB is not responsible for any loss or damage caused by a non-functioning product. Its responsibility is strictly limited to the replacement of the product.

CE APPROVAL

LK CubicSecure water safety system is tested and approved by a third party.

EU Declaration of Conformity, Radio Equipment

Hereby, LK Systems declares that the radio equipment type CubicSecure - LTCS01 is in compliance with Directive 2014/53/EU. The full text of the EU declaration of conformity is available on www.lksystems.se/sv/teknisk-dokumentation/

