

LK Combi Cabinet VS2 Prefab

DESIGN

ARTICLE NO: 298 91 73

These assembly instructions are intended for use with the LK Combi Cabinet VS2 Prefab. Installation must be carried out in accordance with *Industry Regulations for Safe Water Installation*. www.sakervatten.se.



NOTE!

Read all the assembly instructions before carrying out any installation work.

The LK Combi Cabinet VS2 Prefab is used in systems where underfloor heating is installed on the first floor and radiators on the second floor. The LK Combi Cabinet has a width of 1,050 mm.

The LK Combi Cabinet VS2 Prefab is delivered with prefitted shunt, a radiator manifold, pipe lead-throughs, a bellow sleeve for drainage, a 1.5 metres conduit for drainage, a drainage elbow with outlet plate, cable grommets for room control, splash protection and assembly instructions. Contact LK for other variants and customised cabinet solutions. Systems.



NOTE!

The cabinet is configured for right-hand installation. The connection to the shunt unit is done on the cabinet's right hand side, via the bottom of the cabinet.

The bottom of the cabinet is sealed and has rubber pipe lead-throughs. The bottom of the cabinet is fitted with a drainage opening which allows any water leakage to run off to a location that can be inspected.

A frame and a hatch must be fitted to the cabinet. For external installation, a base has to be fitted to the cabinet that hides pipes between the cabinet and the floor.

LK Frame/hatch UFH INB

Used when fitting cabinets in walls. The frame/hatch has a flared frame to cover the holes around the cabinet.

LK Frame/hatch UFH EXT

Used when cabinets are fitted on walls. The frame/hatch ends flush with the outer edges of the cabinet.

LK Base UFH

Accessory for the LK Frame/hatch UFH EXT which conceals the pipe installation between the cabinet and the floor. The height of the LK Base can be adjusted between 231-291 mm.

LK Wet zone hatch PRESEAL

In rooms with sealing layers on walls, the shunt cabinet must be supplemented with a LK Wet zone hatch PRESEAL, which is connected to the wall's sealing layer. Service openings (wet zone hatch) must not be fitted in bathrooms or shower areas.



Picture of LK Combi Cabinet VS2 Prefab.



Accepterad
monteringsanvisning
2021:1

TABLE OF CONTENTS

Design	1
Supplied with the product	2
Installation requirements	3
Installation - Workflow	4
Assembly aids	8
Dimension drawings	10
Pipe dimensions	11
Article data för frame, hatch and base	11



SUPPLIED WITH THE PRODUCT

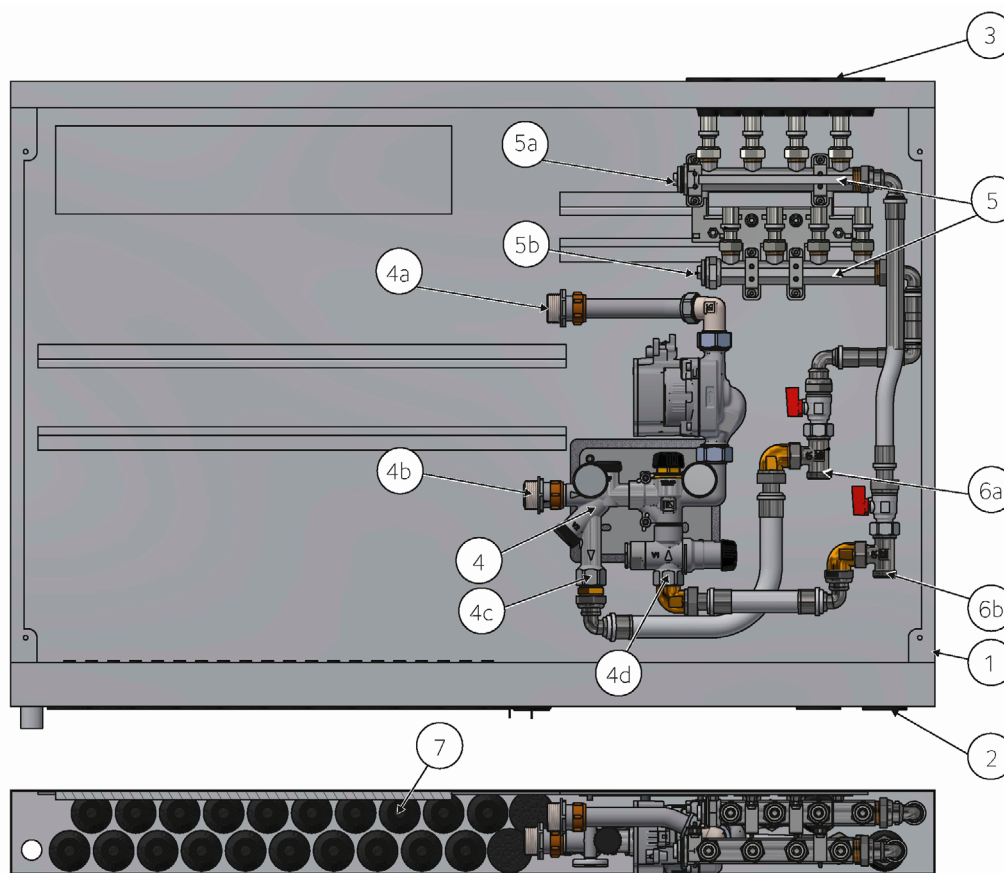

No.	Designation	Quantity	Article no.
1	Shunt cabinet VS2 1,050 x710 cm	1 pc.	243 53 62
2	Pipe inlet 20-25 LP	2 pcs.	188 27 22
3	Pipe inlet 25 LP(conduit)	8 pcs.	187 44 83
4	LK Manifold Shunt VS2	1 pc.	243 52 14
4a	Supply pipe for underfloor heating circuit. Male thread G25.	1 pc.	Included in LK Manifold Shunt VS2
4b	Return pipe for underfloor heating circuit. Male thread G25.	1 pc.	Included in LK Manifold Shunt VS2
4c	Return connection to primary circuit. Female thread G20.	1 pc.	Included in LK Manifold Shunt VS2
4d	Supply connection from primary circuit. Female thread G20.	1 pc.	Included in LK Manifold Shunt VS2
5	LK Manifold UNI 4-G15, 3/4", 1/2"	2 pcs.	187 06 91
5a	Supply pipe radiator circuit UNI G20	1 pc.	481 44 02
5b	Return pipe radiator circuit UNI G20	1 pc.	481 44 02
6a	Return pipe primary side, LK UNI T-Pipes 3/4" G20 Eurocone	1 pc.	188 24 18
6b	Supply pipe primary side, LK UNI T-Pipes 3/4" G20 Eurocone	1 pc.	188 24 18
7	Pipe lead-through 8-20 LP	22 pcs.	298 61 50



INSTALLATION REQUIREMENTS



NOTE!

Service openings must not be fitted in bathrooms or shower areas.

Wet zone 1.



Wet zone 1 for baths and showers.



Wet zone 1 for showers.

Installation in stud walls

- A stud-frame thickness of at least 95 mm is required for in-wall installations.
- When installing in rooms with wall sealing layers, the LK Wet zone hatch PRESEAL requires an installation depth of at least 75 mm measured from the wet room sheet to the front edge of the LK shunt cabinet. For more information, see separate product range and assembly instruction sheets for LK Wet zone hatch PRESEAL.
- Pay extra attention to how deep the cabinet is fitted in relation to any insulated feed pipes. Refer to the illustration given in installation step D.

Installation height

If the design of the structure does not allow the pipes to be fitted at right angles for lower installations, the base of the cabinet must be placed at least 500 mm above the top of the upper edge of the floor joist.



Picture of fitting a cabinet 500 mm from floor surface.

INSTALLATION - WORKFLOW

The cabinet is installed in accordance with the instructions with the exception of the installation of the LK Manifold Shunt VS2, which is already pre-fitted on delivery.

Step A - Preparing pipe lead-throughs



NOTE!

If the seal is damaged while being cut, it must be replaced with a new one.

Prepare the pipe lead-throughs for feeding pipe and underfloor heating pipe.

1. Adjust/cut the lead-throughs to the correct size based on the pipe dimension.

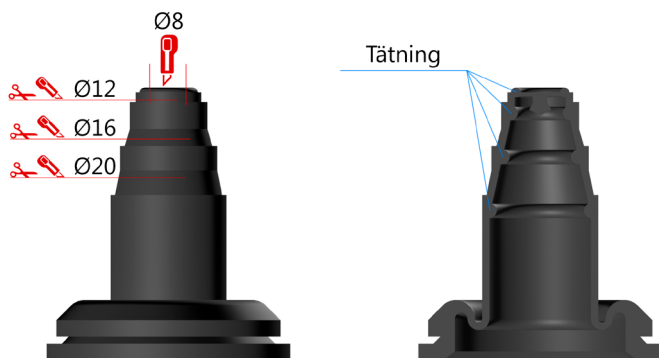

Cutting pipe lead-through.

A cross-section showing the position of the pipe seal.

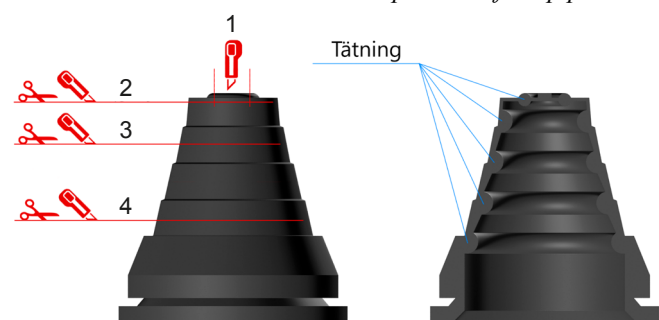

Cutting pipe lead-through.

A cross-section showing the position of the pipe seal.

Cutting level	Dim. pipe	Dim. conduit (PiP)
1	Ø12	-
2	Ø16-20	-
3	Ø25	Ø25
4	Ø32	Ø34

Step B. Knock out the knock-out hole

1. Knock out the required number of knock-out holes for cables for room control.
2. Fit the cable grommets.
3. If the feed pipes have to be connected from the side, the knock-out holes on the side of the cabinet are knocked out.
4. Then the pipe lead-throughs for the feed pipes are fitted in place.

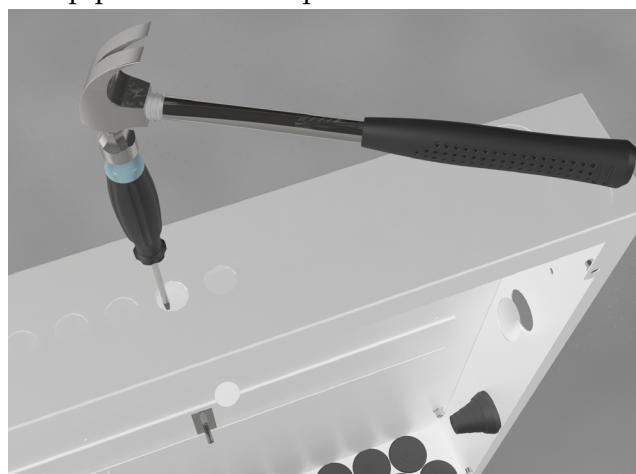

Knock out the knock-out holes using a hammer and a screwdriver.

Step C - Fit the grommets and sealing plugs



NOTE!

Pay particular attention during the installation of pipe lead-throughs and sealing plugs to ensure the bottom of the cabinet is sealed.

1. Fit the adjusted pipe lead-throughs and the LK Sealing Plugs before the cabinet is fitted into place.
2. Fit the LK Sealing Plugs so that the LK Logo can be seen inside the cabinet.



Fit pipe lead-throughs and sealing plugs.



Step D. Installing the cabinet

The back of the cabinet has four pre-fitted M8 nuts that can be used to attach it to the LK Cabinet stand when you wish to fit the cabinet before a concrete slab is cast.



NOTE!

The cabinet should never be installed further out than flush with the stud-frame, so that the frame/hatch UHF INB can be installed.



NOTE!

If the cabinet is mounted recessed in an outer wall, it has to be installed on the heated side of the structure, inside the airtight foil.

1. Fit the cabinet in the stud wall or on an existing wall. Refer to the *Installation Requirements* section for information about stud-frame thickness.
2. Attach the manifold cabinet to the building structure. For wood stud constructions, use the screws and sealing plates supplied. The cabinet can also be attached using the LK Leg Stand.
3. Pay attention to how deep the cabinet is fitted in relation to any pipe insulation. See example in illustration below.

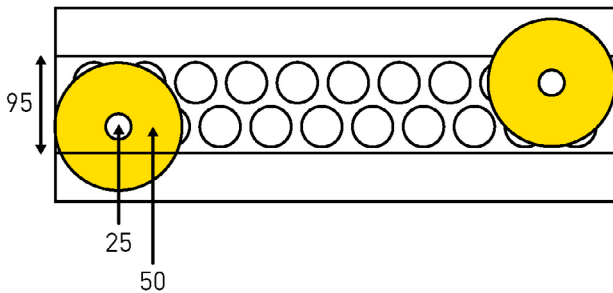

Example, installation with insulation on feed pipe.
The illustration shows a cabinet with a depth of 95 mm.



Attaching a cabinet to a stud wall.

Step E. Fitting manifold and manifold shunt



NOTE!

When installing Prefab cabinets, the VS2 manifold is already fitted. The RF manifold is not fitted.

1. Fit the bracket fixtures to the cabinet rail. See the *Installation of LK Manifold RF picture*.
2. Fit the LK Manifold RF to the bracket fixtures.
3. Then follow the assembly instructions provided for the manifold and the shunt.
4. Carry out a *Pressure and tightness check* on the pipe connections according to the assembly instructions provided.



Installation of LK Manifold RF.

5. Fit the shunt bracket in the designated place in the cabinet if it is not already pre-fitted.
6. Then fit the shunt unit to the bracket.
7. Slide the manifold onto the shunt unit and connect the couplings.

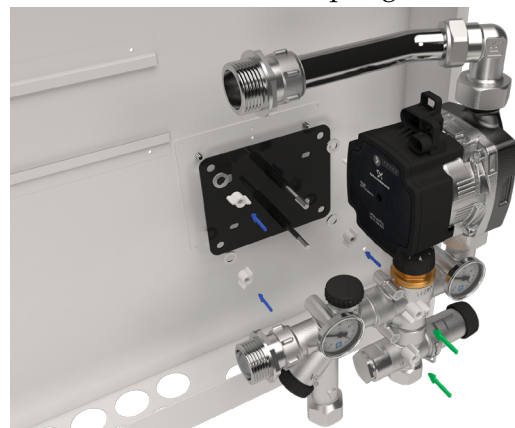

Installing the shunt bracket VS2.

Step F - Pipe lead-throughs

1. Run the underfloor heating pipes through the pipe lead-throughs. This step can be made easier if the pipes are lubricated with soapy water or equivalent.
2. Connect the pipes to the manifold.
Refer to the manifold instructions provided.



NOTE!
Check to ensure the pipe lead-throughs are correctly fitted once all pipes have been installed according to Step F.

3. Draw the coupling on the manifold into the LK Prefab Cabinet.
4. Check that the O-ring in the pipe inlet, if one is fitted, is located in a dip in the corrected conduit.
5. Secure the conduits using LK Fixing Plate or fix in some other way to ensure the pipe right angle rise. It is important to insert the pipes straight at right angles to the cabinet to ensure the base is sealed.

Assembly of LK Conduit umbrella LP

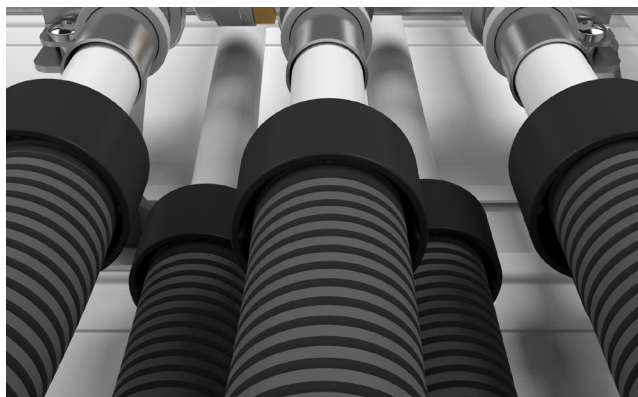

Illustration example. Monting of the LK Conduit umbrella LP.

The LK Conduit Umbrella LP or an equivalent option such as LK Sealing Socket should be installed on coupling pipes. The LK Conduit Umbrellas LP should be installed on the media pipe and pressed down towards the conduit.

6. Install LK Sealing Socket 60-50 40/34 32 25 20 on the supply line to ensure that any leaking water is discharged onto cabinet bottom. If necessary, adjust the LK Sealing Socket.

Pressure and tightness check

Pressure and tightness check must be carried out in accordance with “Assembly instructions for LK PE-X, PAL and PE-RT pipes” or according to industry regulations on “Safe water installation”.

Step G - Installing cabinet drainage



NOTE!
Drainage outlets from a cabinet with tap water installation must always drain onto an area with a floor drain or waterproof flooring.



NOTE EXCEPTION!
Cabinets that are placed in stairwells may have leakage indication sensors that open into the stairwell on a watertight or waterproof floor. The exception does not apply to a single residence building.

- Drainage outlets from cabinets in heating system installations can run off from the wall surface under the cabinet in rooms normally in use to detect any leakage.
- For pipe lead-throughs in walls, the distance between the pipe and the adjacent wall or the floor’s sealing layer must be at least 60 mm.
- Leakage indication sensors must not be fitted in bathrooms or shower areas.

Fitting drainage elbows

The drainage elbows can be fitted in different ways:

- Drainage elbow connected directly to the cabinet’s outlet pipe.
- Connecting drainage pipes.
- Drainage elbow connected via a conduit.

Refer to pages 6-7 for the different installation steps.

Drainage elbow connected directly to the cabinet’s outlet pipe

Drainage run off from the wall surface under the cabinet. For cabinets mounted on the wall, the drainage elbow opens out into the pre-drilled hole in the base.

1. Connect the drainage elbow directly to the cabinet’s outlet pipe after all pipe inlets and sealing plugs have been installed.
2. Then attach the drainage elbow to a wall stud in a suitable position. Use the two installation screws supplied in any of the fixing holes.



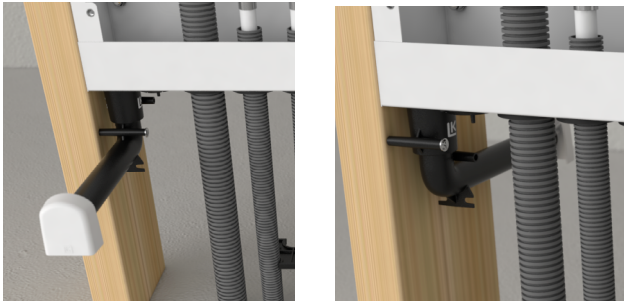

Illustration A drainage elbow directly connected to the cabinet's outlet pipe will drain into the same room as the cabinet's service hatch or, alternatively, the room behind.

Drainage elbow connected via a conduit.

1. Connect the conduit to the cabinet's drainage pipe using the bellow sleeve. The bellow sleeve must not be kinked as this could prevent the flow of any water leakage.
2. Connect the drainage elbow to the conduit. Note that the pipe must be pushed all the way into the drainage elbow, approximately 20 mm deep.
3. Then attach the drainage elbow to a wall stud in a suitable position. Use the two installation screws supplied in any of the fixing holes.
4. Ensure that the entire conduit is installed with a fall in its entire length towards the outlet and that the conduit is secured.

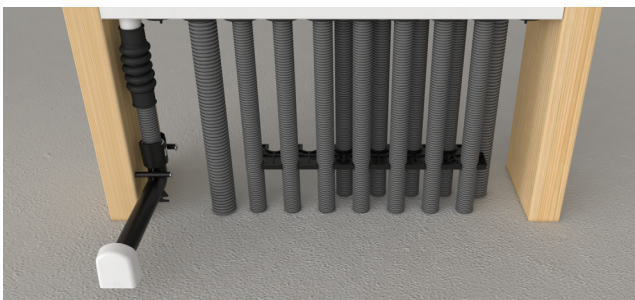

Illustration Drainage elbow connected via a conduit.

Connecting drainage pipes

It is possible to connect drainage pipes from two cabinets. The picture below shows side-by-side installation but drainage pipes can also be connected when the cabinets are mounted further apart.

1. Use the LK Drainage Kit 25 Duo.
2. Then attach the drainage elbow to a wall stud in a suitable position. Use the two installation screws supplied in any of the fixing holes.

3. Ensure that the entire conduit is installed with a fall in its entire length towards the outlet and that the conduit is secured.

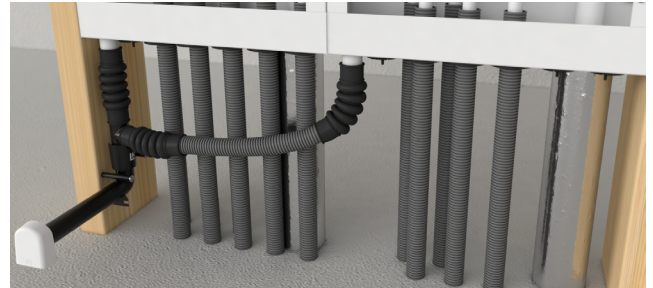

Illustration Connecting drainage pipes.

Fitting outlet plate

1. Mount a wallboard with a hole for the drainage elbow outlet pipe. Hole diameter approx. 26 mm. Apply any sealing layer as per the instructions from the waterproofing supplier.
2. Once the wall panelling is installed, the drainage elbow should be cut to size using the LK Pipe Mill V2. Alternatively, the drainage elbow can be cut to a suitable length using a tool such as a hacksaw blade.
3. Be careful not to damage the surface layer, and leave 2-3 mm of the outlet pipe protruding from the wall. In rooms with sealing layers on walls, leave 6-9 mm.
4. Fit the LK Outlet Plate V2 to the outlet pipe. The LK Outlet Plate V2 Chrome is available as an accessory for a more stylish finish.

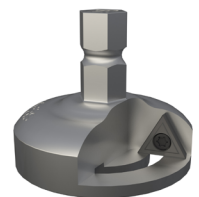

Illustration Installing the LK Outlet Plate V2.

Accessories



LK Outlet Plate V2 Chrome, Article no. 188 26 14.



LK Pipe Mill V2 Article no 1882615.



Step H - Fitting splash protection

1. Fit the splash protection supplied.
Take care to ensure that the protection protrudes at the side so that the entire width of the cabinet is covered by the protection.

Step I - Fitting the Frame/hatch

There are two types of frames/hatches depending on whether the cabinets are built into or installed externally on an inner wall. In rooms with sealing layers on walls, the LK manifold cabinet must be supplemented with a LK Wet zone hatch PRESEAL which is connected to the wall's sealing layer. Service openings (wet zone hatch) must not be fitted in bathrooms or shower areas.

Fitting the Frame/hatch UFH INB

When the cabinet is fitted into a wall, use an LK Frame/hatch UFH INB, which has a flared frame to cover the holes around the cabinet. The frame covers an area of 15 mm beyond the edge of the cabinet.

1. Fit the LK Frame/hatch using the M5 screws provided. Use longer screws (not included) if the cabinet is mounted deeper in the wall structure.

Fitting Frame/hatch UFH EXT

When the cabinet is fitted externally on a wall, use LK Frame/hatch UFH EXT which ends flush with the outer edges of the cabinet.

1. Fit the frame using the four screws and mounting plates provided. Refer to picture. Fit the four white cover plugs on the side of the cabinet.

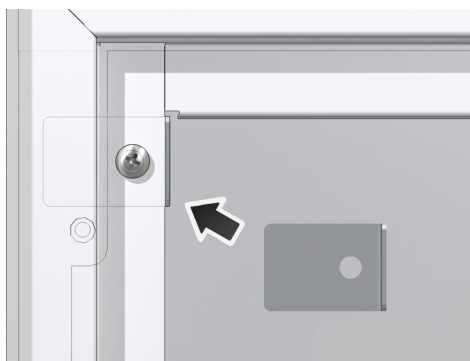

Plate and screws for LK Frame/hatch UFH EXT.

Fitting the base

1. With an external installation of the LK Shunt Cabinet VS2, fit the LK Base by first pushing the upper part of the base into the intended slots in the cabinet frame.
2. Also ensure that the drainage elbow opens out into the intended hole.
3. The lower part of the base is then pulled out to touch the floor.
4. When the correct height has been reached, the installation is secured using the screws on the front of the base.



LK Base, installation.

5. Then adapt the length of the drainage elbow to the outside of the base and fit the outlet plate.

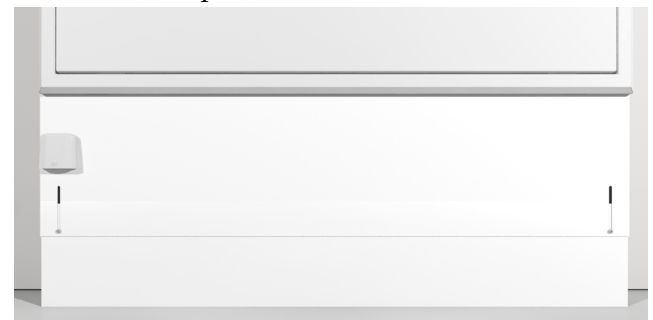

Outlet plate fitted on base.

INSTALLATION AIDS

Installation using the LK Cabinet Stand L2

The back of the cabinet is fitted with four attachment points (M8 nuts) which can be used to mount the cabinet before the concrete slab is cast. The LK Cabinet Stand L2, which is installed as shown below, is available as an aid.



LK Cabinet Stand L2 with attachment clips. RSK 243 55 16.

1. Insert the four M8 bolts supplied in the back of the cabinet.
2. Screw the pipe clamps on to the protruding bolts.
3. Thread in the round bars and slip on the conduit parts supplied with the stand. The conduit prevents the stand from getting stuck in the concrete, and as a consequence the stand can be used again.
4. Knock down the round bars through the insulation and down into the sand until the installation feels stable.
5. Raise the cabinet up to a suitable height and tighten the clips.
6. Tape the conduits to the stand legs to prevent the conduits from rising up while the concrete is laid.



Fitted cabinet stand.

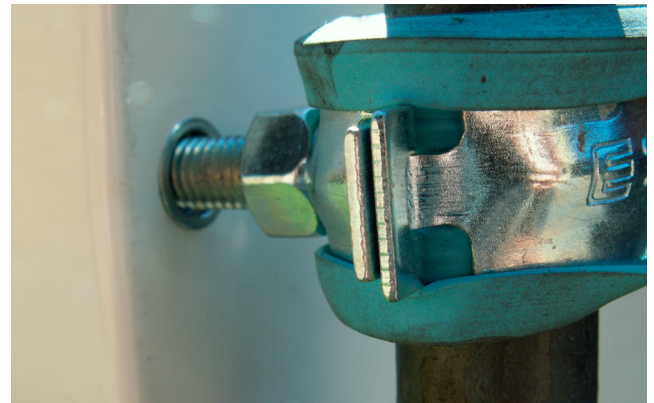

Close-up of attachment to cabinet.

Installation using LK Leg Stand

The LK Leg Stand simplifies cabinet assembly on prefabricated concrete joists. Manufactured from galvanized steel plate. Delivered in pairs with 4 self-tapping screws to fix to the manifold cabinet. The feet on the leg stand have 6 mm holes to attach it to the concrete floor structure. The legs are fixed using a bolt or metal nail plug (not supplied).

In cases where the manifold cabinet is not adequately secured by the leg stand, then the cabinet should also be secured to the wall.



LK Leg Stand.

DIMENSION DRAWINGS

LK Frame/hatch UFH EXT

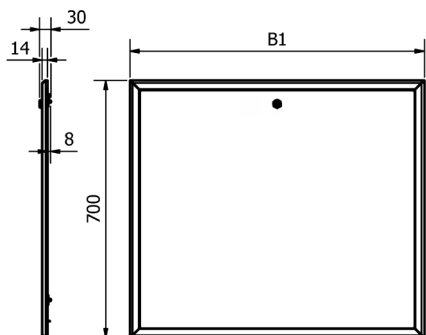

LK Frame/hatch UFH 1050 INB

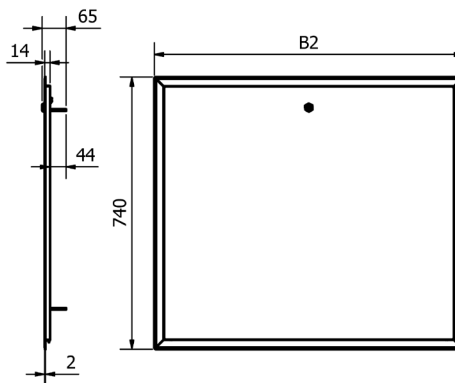

LK Combi Cabinet VS2 Prefab

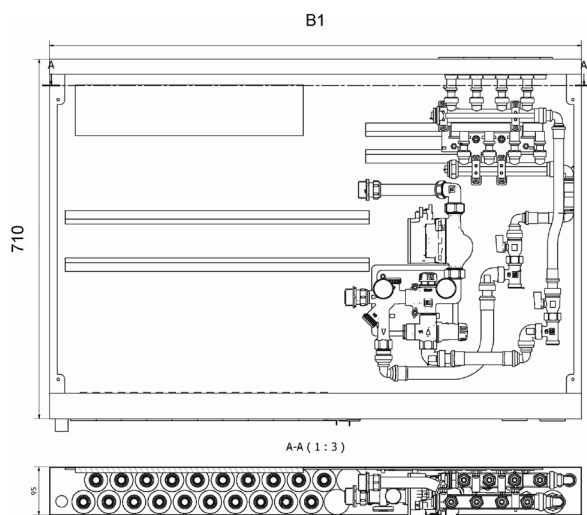

LK Base 1050

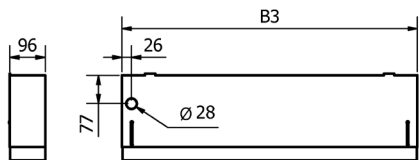

Cabinet	B1 mm	B2 mm	B3 mm	Knock outs	
				B4 mm	B4 mm
1050	1050	1090	1053	24 + 2	1020



PIPE DIMENSIONS

The table below shows which dimensions and pipe types can be connected to the LK shunt cabinet VS2/ LK shunt cabinet VS2 prefab. For more information on products included in the LK underfloor heating system, browse to www.lksystems.se/en (products/lk-golvvarme/products/Pipes/).

Pipe lead-through	PE pipe	Steel pipe	PiP (pipe in pipe) conduit dimension
Pipe lead-through 8-20 LP	8, 12, 16 & 20 mm	-	-
Pipe lead-through 20-25 LP for feed pipe in PE	20, 25 & 32 mm	22 & 28 mm	34 mm
LK Pipe inlet 8, Quattro*	8 mm	-	-
LK Pipe Inlet 32 PiP LP*	32 mm	-	40-44 mm

*ordered separately.

ARTICLE DATA FÖR FRAME, HATCH AND BASE

Name	Article no.	Designed for:
LK Frame/hatch UFH EXT	243 53 64	External installation of UFH cabinet 1050
LK Frame/hatch UFH 1050 INB	243 53 63	In-wall installation of UFH cabinet 1050
LK Base 1050	243 53 65	External installation
LK Wet zone hatch PRESEAL* 1,050x710	188 26 41	LK Shunt cabinet M60n XL

*ordered separately. For more information, see separate product range and assembly instruction sheets for LK Wet zone hatch PRESEAL.

