

Grundfos UPM3 Auto 15/70

INTRODUCTION

Grundfos UPM3 Auto 15/70 is a compact, energy-saving and high-performance pump specifically developed for the OEM market. LK uses UPM3 Auto in several products because of its good characteristics.

The pump has ten different setting options, three curves for Proportional Pressure, three curves for Constant Pressure and four curves for Constant Curve. The recommendation for underfloor heating is Constant Pressure and a curve that is adapted to conditions for the installation. The pump is set to Proportional Pressure, curve three, on delivery.

OPERATING MODE / SETTINGS MODE

Grundfos UPM3 Auto indicates in normal operation the setting currently in use by the pump. Read the selected mode by studying the settings menu.

To change the pump setting press the button on the pump. Then the pump shifts to the selected setting in accordance with the settings menu. Pressing the button  shifts the pump between the different settings. Adjust to the desired setting using the menu.

Note that for floor heating Constant Pressure is recommended with a curve that is suitable for the installation needs.



TABLE OF CONTENTS

Introduction	1
Operating mode - Settings mode	1
Settings menu	1
Alarm codes	2
Dimensions	2
Pump diagram	2
Electrical contact	2























	CONSTANT PRESSURE 1	
	CONSTANT PRESSURE 2	
	CONSTANT PRESSURE-3MAX	

Table, overview of operating mode.



Note!
The pump is set to *Proportional Pressure*, curve three, on delivery. This must be manually changed to *Constant Pressure* by the installer when the pump is used in floor heating installations.

SETTINGS MENU

	OPERATING PANEL	CONTROL MODE	
0		PROPORTIONAL PRESSURE AUTO ADAPT	
1		CONSTANT PRESSURE AUTO ADAPT	
2		PROPORTIONAL PRESSURE 1	
3		PROPORTIONAL PRESSURE 2	
4		PROPORTIONAL PRESSURE 3 - MAX	
5		CONSTANT PRESSURE 1	
6		CONSTANT PRESSURE 2	
7		CONSTANT PRESSURE-3MAX	
8		CONSTANT CURVE 1	
9		CONSTANT CURVE 2	
10		CONSTANT CURVE 3 - MAX	

Overview of settings options for the UPM3. Relevant settings are marked with a blue triangle, other settings are shaded.



ALARM CODES

In the event of an operating problem then a fault code will be displayed as below.

Display	Indication	Operation	Action
Red LED, Yellow LED #5	Blocked rotor	False start was 1.33 s.	Wait or release rotor
Red LED, Yellow LED #4	Too low voltage	Only one warning, the pump operates as normal	Check the voltage to the pump
Red LED, Yellow LED #3	Electric fault	Pump stops because of low voltage or serious fault	Check voltage to pump / Replace pump/ impeller*

*Release impeller using screwdriver PH2. Break the voltage to the pump. Insert the screwdriver into the center hole of the drive side, press the screwdriver in about 5 mm, then rotate forward /backward until the impeller loosens.

ELECTRICAL CONTACT

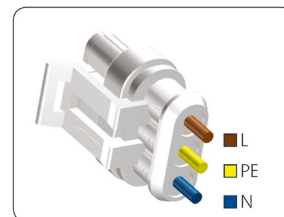
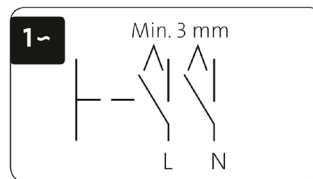

The pump's electrical contact should be connected to a 230 V 50 hz socket by a qualified electrician in accordance with the diagram above. This contact no longer requires a 2-pole switch disconnecter. The electrical contact should be equipped with a slow-blow fuse of up to 10 A. The pump should be disconnected from the mains before any maintenance work.

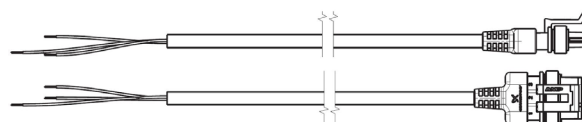

DIMENSIONS

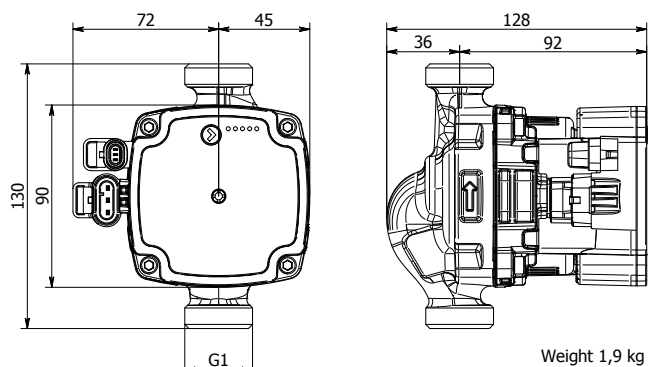

Grundfos UPM3 Auto 15/70 130

PUMPDIAGRAM

