

# On floor joists with cross battening & LK Heat Distributing Plate 16

## DESIGN

LK Under Floor Heating laid in cross battening is intended for wood floor joists. The construction is built up with cross battening and requires a bearing capacity of the construction corresponding to that of a 22 mm chipboard floor laid on joists of maximum c/c 600 mm. With maximum dimension c/c 600 mm between floor joists, one of LK's under floor heating systems; HeatFloor 22 or LK Floor Joist Plate can also be used.

The cross battening can be installed in floor joists or lowered between the floor joists. See section *Procedure between floor joists*.

## REQUIREMENTS

We recommend that to achieve optimum efficiency of under floor heating systems the use of weather dependent (weather compensation) flow temperature control, properly balanced and set in line with the design for adjustment of the primary and loop flow. We also recommend the settings are recorded for future reference.

In general the guidelines apply in accordance with local building codes and for selected bespoke design solutions.

## CONSTRUCTION OUTLINE

### 1. Floor joists

### 2. Insulation

Joist insulation should fill up the entire joist compartment. The intermediate joist is not usually fully insulated. But to avoid any problems with cooling underside of the plates at the leaky/drafty floor is recommended that the insulation fills up or rest against the underside of the plate.

### 3. Cross battening

Cross battening laid over wood joists with c/c 600 mm must be at least 28 mm thick and 70 mm wide.

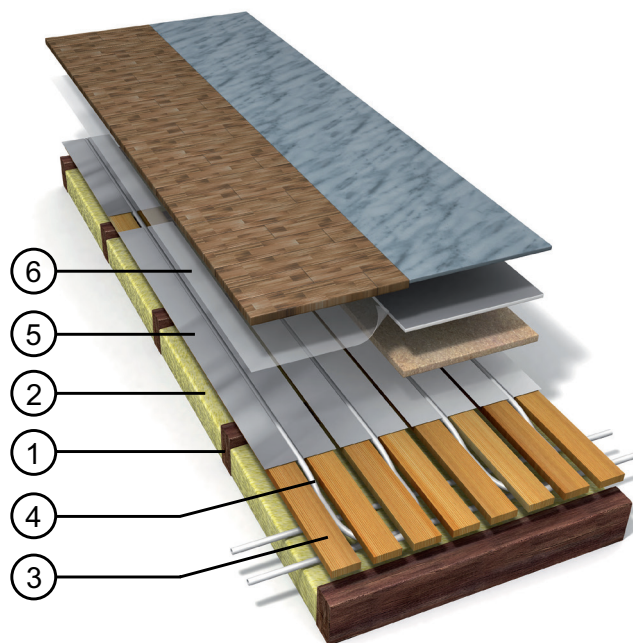

### 4. LK Universal Pipe Dim. 16 mm

### 5. LK Heat Distributing Plate 16/190 dim. 1150 x 190 mm

LK Heat Distributing Plate 16/190 is made of aluminium and is suitable for LK Universal Pipe 16 mm. The amount of material required is approx. 4 LK Heat Distribution Plates 16, cover 1 m<sup>2</sup>. We recommend you wear gloves when handling the plate, as some of the corners and edges may be sharp.

### 6. Vapour barrier according to the floor manufacturer's instructions and cell foam / rag board.

## SURFACE LAYER

The floor constructions illustrated bellow requires that the floor joists are at c/c 600 mm and that the cross battening must be at least 70 mm wide and 28 mm thick.

### Parquet, solid wood or laminated floor

Cover the floor heating with damp barrier (age constant plastic) and there after rag paper or cell foam. Lay the upper floor min. 14 mm thick across the direction of the cross battening. The flooring should be installed in line with manufacturers instructions. Always consult LK for floor thicknesses above 25 mm.

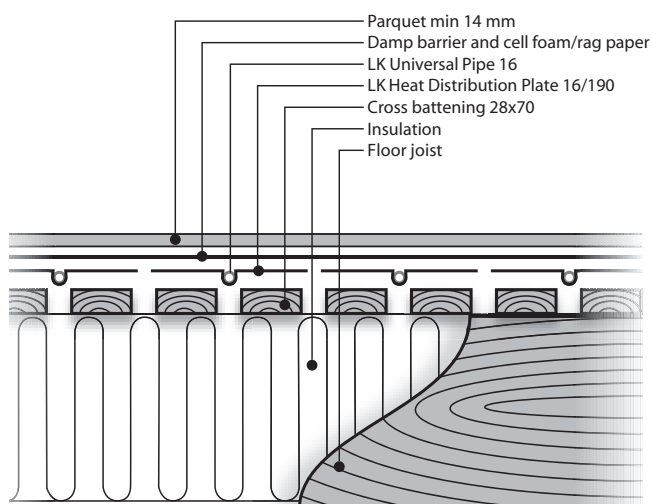

*LK Heat Distribution Plate 16/190 on cross battening on floor joists. Surface layer parquet.*

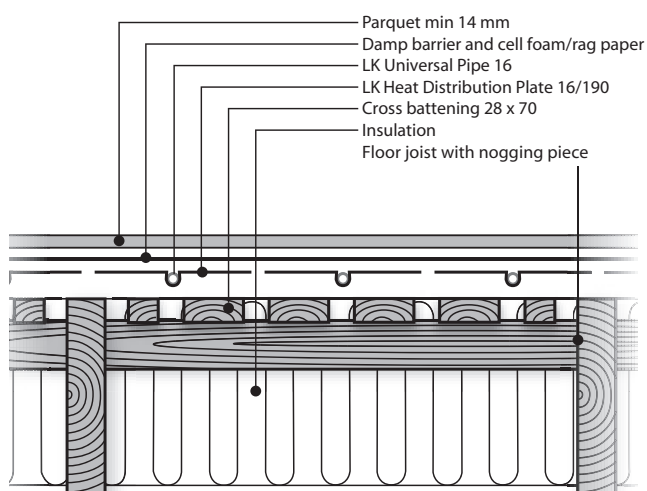

*LK Heat Distribution Plate 16/190 on cross battening between floor joists. Surface layer parquet.*

## Vinyl or linoleum flooring and carpet

### Dry areas

When vinyl, linoleum or carpet coverings are to be used, 18 mm floor grade chipboard must be screwed in place over the under floor heating as the suppliers instruction. Lay the carpet according to the supplier's instruction.

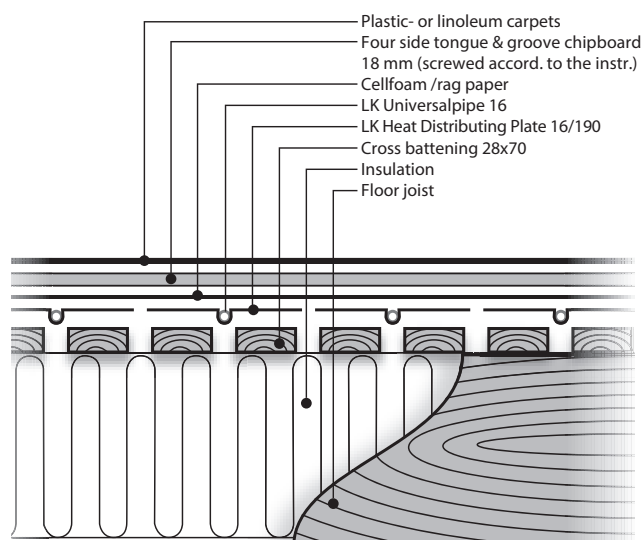

*Heat Distribution Plate 16/190 on cross battening on floor joists. Surface plastic- or linoleum carpets in dry areas.*

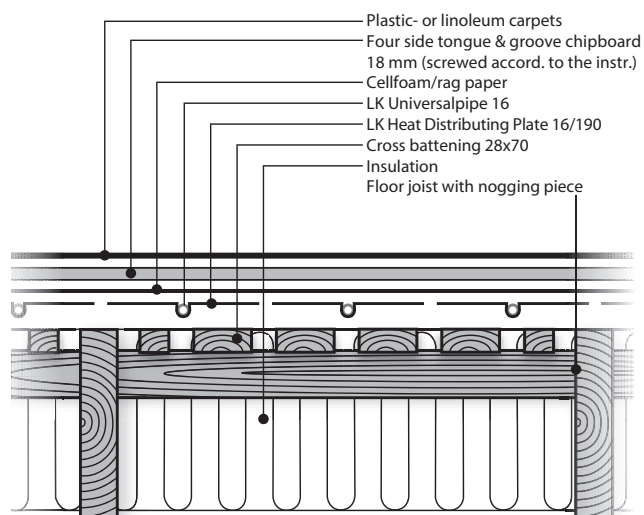

*Heat Distribution Plate 16/190 on cross battening between floor joists. Surface plastic- or linoleum carpets in dry areas.*

### Wet areas

For wet areas (shower/bathrooms) where vinyl is to be used, 22 mm floor grade chipboard must be screwed in place over the under floor heating as the suppliers instruction. Apply primer and levelling compound to create a sloping floor in wet areas, min. 12 mm by floor drain. Follow the suppliers instructions.

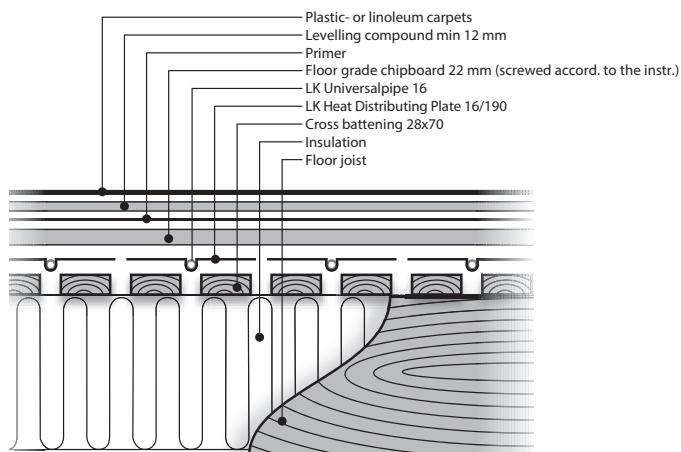

*Heat Distribution Plate 16/190 on cross battening on floor joists. Surface plastic- or linoleum carpets in wet areas.*

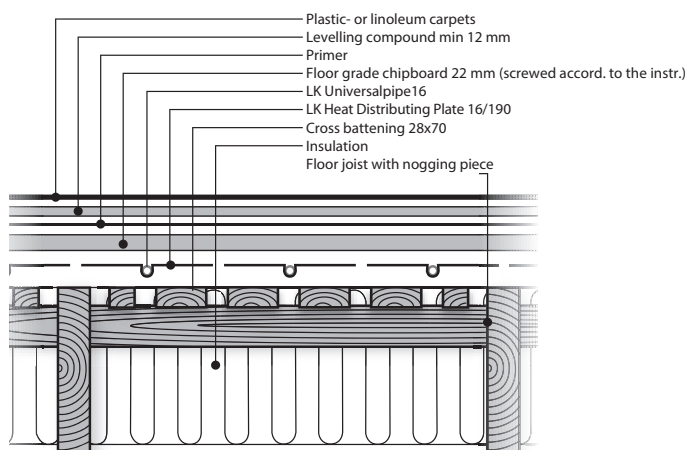

*Heat Distribution Plate 16/190 on cross battening between floor joists. Surface plastic- or linoleum carpets in wet areas.*

### Ceramic and Stone Tiles

#### Dry areas

Tiles require an intermediate floor, over the under floor heating, of 18 mm floor grade chipboard. Screw in place over the under floor heating as the suppliers instruction. Glue a 13 mm floor grade form stable board for floors (for example plasterboard or fibre cement board) onto the floor with LK Kiilto Floorfix DF mixed with LK Kiilto Fixbinder and water. Apply the glue with a putty-knife, and then "comb out" the glue with a notched trowel (notched 8 mm). Mount the floor grade form stable board within 10–15 minutes after the glue is applied. To make sure that the boards are in place it's sometimes necessary to screw the boards in place. In these cases it's important to mark out the position of the pipes at the same time, to avoid any damages.

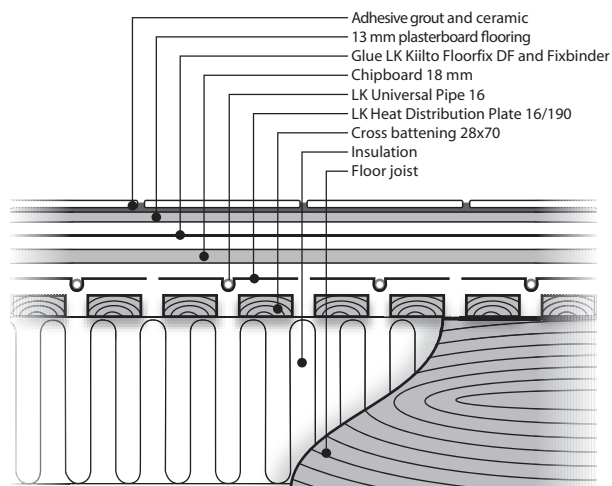

*LK Heat Distribution Plate 16/190 on cross battening on floor joists. Ceramics in dry areas.*

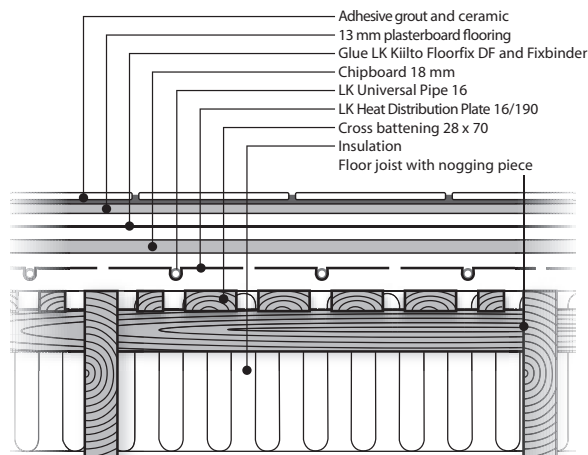

*LK Heat Distribution Plate 16/190 on cross battening between floor joists. Ceramics in dry areas.*

### Wet areas

Tiles require an intermediate floor, over the under floor heating, of 22 mm floor grade chipboard. Screw in place over the under floor heating as the suppliers instruction. Use levelling compound on the boards to create a sloping floor in wet areas, min. 12 mm by the floor drain. After that a damp proof layer and ceramic tiles. Follow the suppliers instructions.

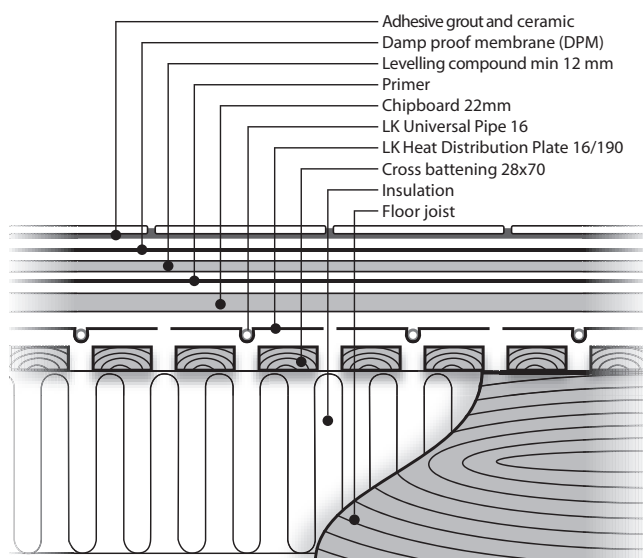

*LK Heat Distribution Plate 16/190 on cross battening on floor joists. Ceramics in wet areas.*

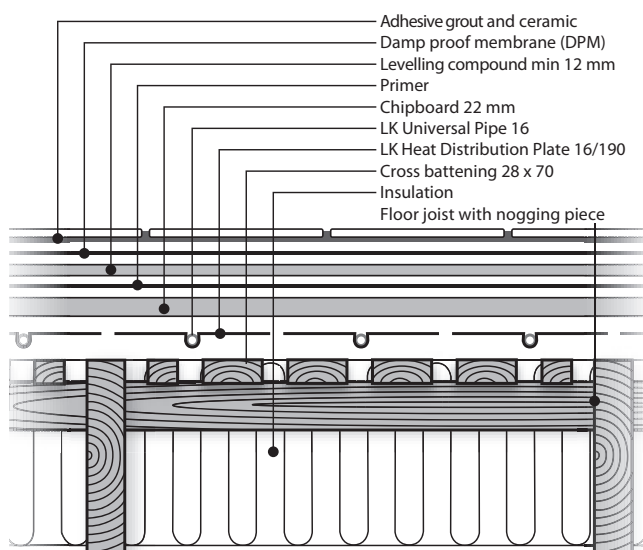

*LK Heat Distribution Plate 16/190 on cross battening between floor joists. Ceramics in wet areas.*

### LK HEATING CIRCUIT MANIFOLD

The LK Heating Circuit Manifold should be installed as shown in the design drawing. Please read the instructions enclosed with the manifold first.

### CROSS BATTENING

Cross battening can be laid in several ways. These instructions include two of them.

#### Procedure on floor joists

Fix the cross battening across the floor joists, with a 30 mm space between them. The cross battening should finish on the last floor joist approx. 25 mm from the end wall. Do not fix the cross battening by the walls where the pipe has its turning zone.

Measurement between cross battening: 30 mm

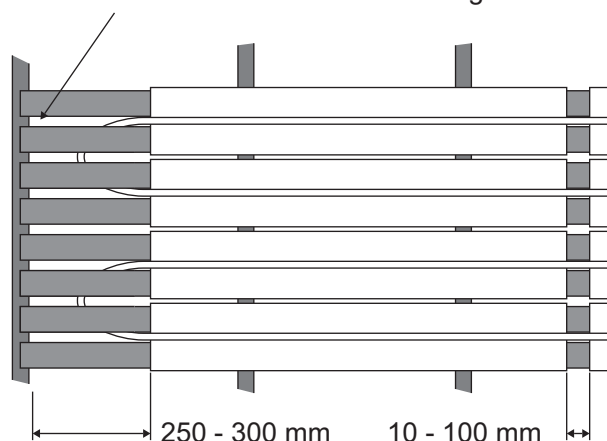

#### Turning zone

Lift the cross battening and bend the pipe under the boarding. After the pipe has been laid, fix the boarding to the floor joist.

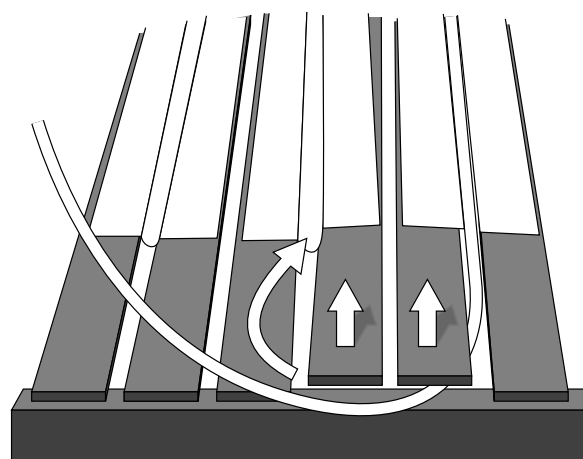

### Procedure between floor joists

In this method the cross battening is fixed to nog-gins between the floor joists. This is done if the under floor heating construction is not to be built over the floor joists. The joist supports are fitted to match the thickness of the cross battening, so that the boarding is on the same level as the upper side of the floor joists. This is to ensure contact between the LK Heat Distribution Plate and the flooring.

If the floor joists are c/c 600 mm, the pipe distance c/c 200 mm will not end up even with 70 mm wide battens. Battens at the sides of the floor joists must then be reduced to 35 mm.

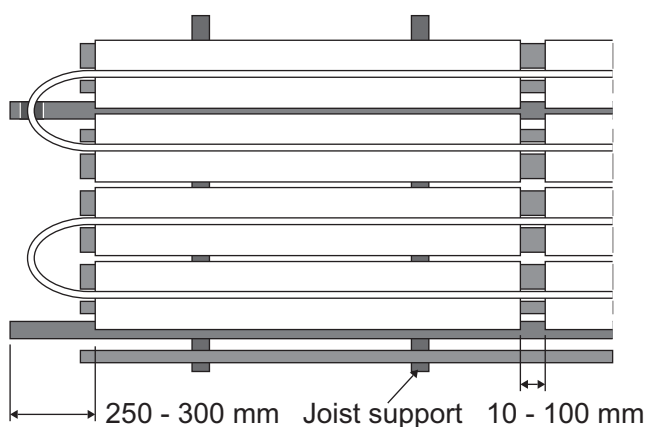

### Turning zone

For transfer to the next joist compartment, the floor joist must be notched out in order to make room for turning the pipe. Bear in mind that notching a floor joist results in a weakening of the construction. Consult the manager responsible for quality or the building engineer.

### LAYING PROCEDURE, HEAT DISTRIBUTION PLATE

Lay the heat distributing plate out and centre in each alternate slot of the boarding, creating a pipe distance of c/c 200 mm. The longitudinal spacing between the plates should be around 10–100 mm. Plates, they can be adapted to cover the length of the room. Finish laying the plate's approx. 250–300 mm from the turning zone of the pipe. Fix down one of the plate's flanges. When pipe laying is completed, secure the other flange.

### LAYING THE PIPE

Lay the under floor heating pipe out according to the layout drawing. Using LK Pipe Decoiler aids pipe laying. Ensure the direction of flow in the loop is such that the supply line is closest to the outer wall. Number and name the loops according to the drawing. Check before you lay the pipe that the plate slots are clean.

Press or tread down the under floor heating pipe into the slot of the plate. After assembly the pipe must lie in the slot and must never under any circumstances touch the overlying surface layer.

Pipes should be cut using pipe shears intended for PE-X.

### EVENNESS OF FLOOR JOISTS

Before the boards are laid, the desired degree of evenness under the floor should be inspected. Maximum curvature  $\pm 3$  mm over a distance of 2 metres and  $\pm 1,2$  mm over a distance of 0,25 metres.

## PRODUCT SUMMARY, ADHESIVE & PRIMER

The following brands/products have been tested to be used for gluing and priming of form stable plate against intermediate floor.

LK art. no.	Product name	Usage	Notes	Consumption	Drying time
33521	Kiilto Start Primer, 3 litres	Priming of the intermediate floor before creating drainage slope. Glueing or filling should be carried out within 24 h after the primer has dried.	Combine only with Kiilto products	1 l/10 m <sup>2</sup>	1–2 hours
33525	Kiilto Floorfix DF, 20 kg	Gluing of the form stable plate against intermediate floor	Mix 5 litres Fixbinder and 2 litres water with 20 kg Floorfix DF	3,5 kg/m <sup>2</sup>	16–32 hours
33522	Kiilto Fixbinder, 5 litres	Gluing of the form stable plate against intermediate floor	Mix 5 litres Fixbinder and 2 l water with 20 kg Floorfix DF	5 l/20 kg Floorfix DF (+2 l water)	Not applicable