

LK Shunt 2/3-6,3

DESIGN

The LK Shunt 2/3-6.3 is intended for systems with a main pump. The shunt can be assembled for both right and left operation model. Pay attention to potential structure-borne sound when positioning and assembling the shunt. This shunt is capable of servicing approximately up to 1000 m² floor heating area. The capacity depends on variables such as heat demand and floor construction. As an option, LK Shunt can be supplied with LK Control v.3, a complete unit for sensing external temperature to control flow temperature. A set is: control unit, valve actuator, external sensor and flow line sensor (see section below and separate information for LK Control v.3). Where other regulating controls are used, LK can supply 230 V or 0-10 V valve actuators.

REQUIREMENTS

Before assembly, the heating system must be flushed and should not contain any impurities or additives which can damage the LK Shunt. Maximum 30% glycol mixture.



The image shows LK Shunt 2/3-6.3.



NOTE!

The LK Shunt is to be assembled with the pump's axis/rotor in a horizontal position and that the valve actuator is not located under the control valve.

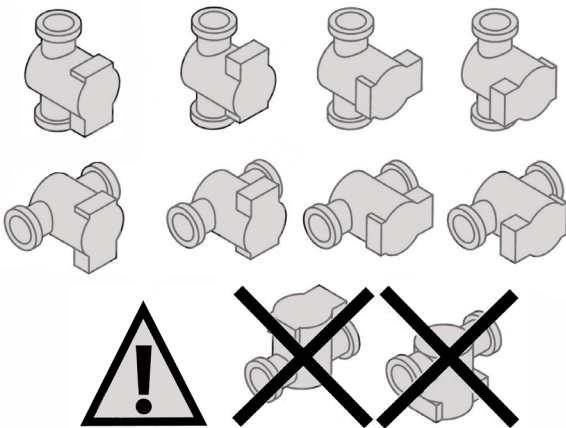
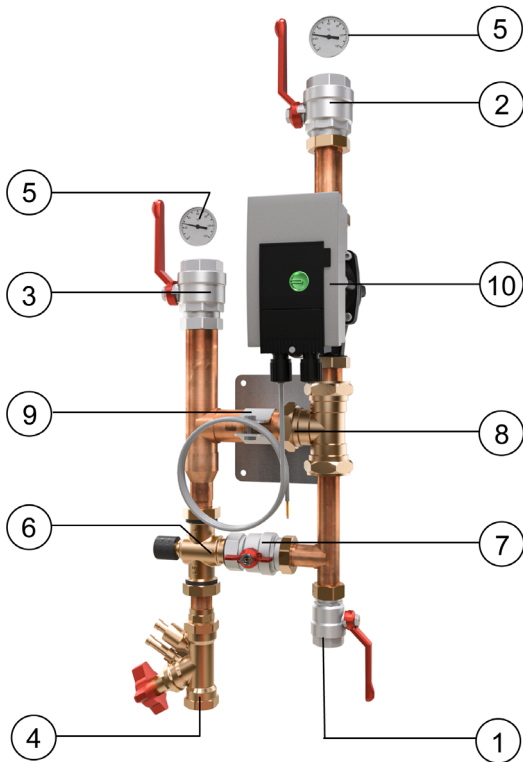

TABLE OF CONTENTS

Design	1
Requirements	1
Construction	2
Circulation pump	2
Capacity chart	3
Setting the pump function selector	3
LK Control v.3 (accessory)	4
Flow diagram	5
Technical data	5
Dimensions	6



CONSTRUCTION



Right or left operation model

Supply line to right or left is optional. (The picture shows the right operation model.) To satisfy customer requirements, the circulation pump and wall mounting are not pre-assembled.

1. Supply line from primary circuit

Ball valve with female thread 1".

2. Supply line to under floor heating circuit

Ball valve with female thread 1¼".

3. Return line from under floor heating circuit

Ball valve with female thread 1¼".

4. Return line to primary circuit

The return line to the primary circuit in the standard design and comes equipped with an TA-STAD connection 1" adjustment valve.

The estimated primary flow must be adjusted according to the tender documents. The values entered must be documented in a self-test report.

5. Thermometers

The thermometers are of surface contact type for location on the under floor heating circuit's supply and returnline.

6. Control valve kvs 6.3

Siemens VPX459.20-6,3

7. By-pass

Isolation valve for switching between 2 or 3-way designs on the control valve.

Open valve = 3-way design.

Closed valve = 2-way design.

8. Check valve

There is an in-built check valve cartridge in the secondary circuit.

9. Wall mounting

10. Circulation pump

Wilo Yonos Para HF 25/7 180, with automatic speed control.

CIRCULATION PUMP

Circulation pump Wilo Yonos Para HF 25/7 180, with automatic speed control, 1 phase 230 V DIN IEC 60038 ±10%, 50/60 Hz.

The circulation pump has automatic speed control, which reduces power consumption and gives a quieter operation as the pump adjusts the flow according to the requirements of the system. A cast arrow on the pump housing indicates the direction of the flow.

For underfloor heating, it is recommended that the pump be set into constant pressure regulation. Choose the constant pressure curve that best corresponds to the needs of the plant, see the *Capacity diagram*. Make sure that the pump is never run dry and that the system is well vented before commissioning. Use the automatic venting function in the pump at start-up.

Electrical connection of circulation pump

Electrical connection of the pump must be carried out by a qualified electrician in accordance with applicable regulations. Motor protection is not required, but in accordance with applicable electrical safety the pump must be fitted with a 2-pole circuit breaker. The mains connection cable comes pre-assembled in the circulation pump by screwing. The free end of the cable should be connected to a 2-pole circuit breaker. Ensure that the cable connection is in the strain relief and protected against drips and condensation.

Connect as follows:

Black/brown cable: L1 (Phase)

Blue cable: N (Neutral)

Green-yellow cable:  (Protective earth)



CAPACITY DIAGRAM

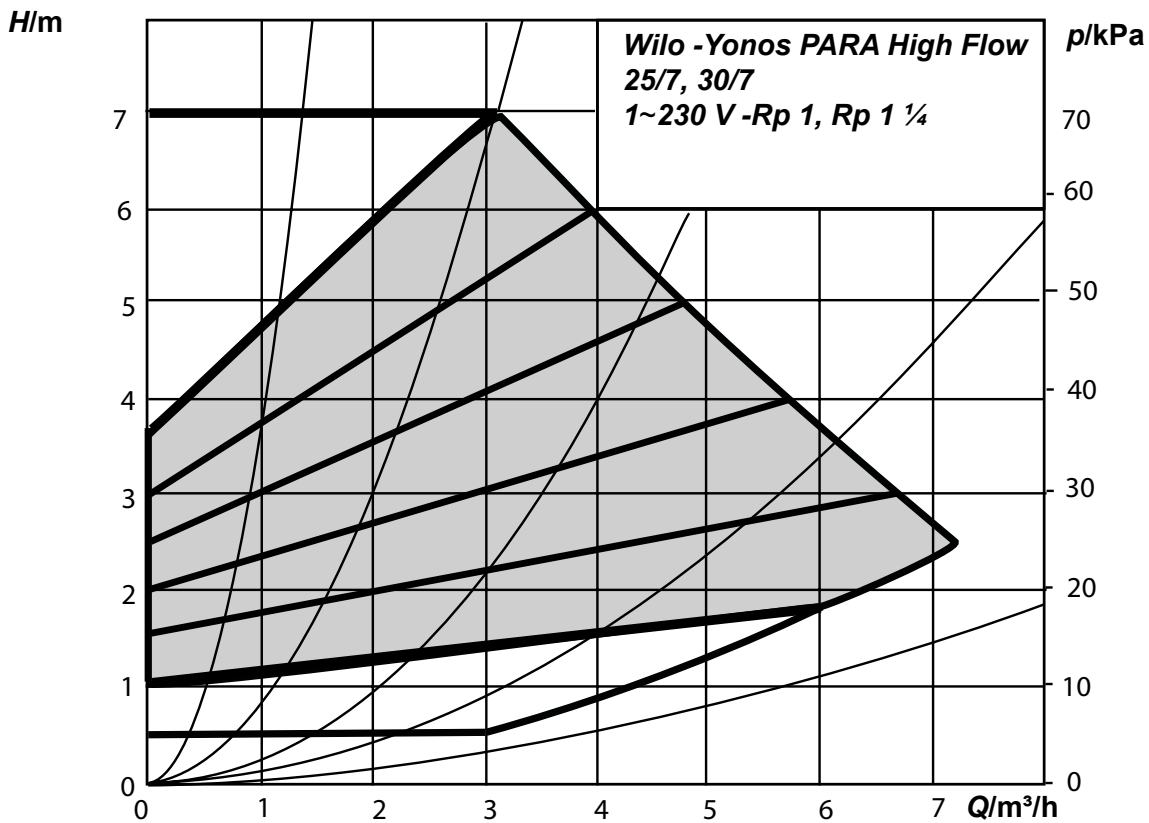

SETTING THE PUMP FUNCTION SELECTOR

For under floor heating it is recommended that the pump is set to constant pressure control. Select the desired capacity with the function selector. *See the overview picture on page 4.*

Ensure that the pump never runs dry and the system is well vented before use. Venting of the pump's rotor chamber occurs automatically after a short period of operation.



Function selector knob with three positions, as well as symbols and diode indication for the setpoint.

4.5

The diode display shows the setpoint value of the pump in meters (m). Turn the function selector to set or change the setpoint.

Constant pressure curve

For under floor heating it is recommended that the pump is set to constant pressure control. Select the constant pressure curve that best matches the needs of the system, see the *Capacity diagram*.



Constant pressure curve icon.

Proportional pressure curve

Proportional pressure setting is normally not used for floor heating.

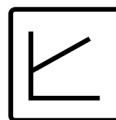

The proportional pressure curve icon.

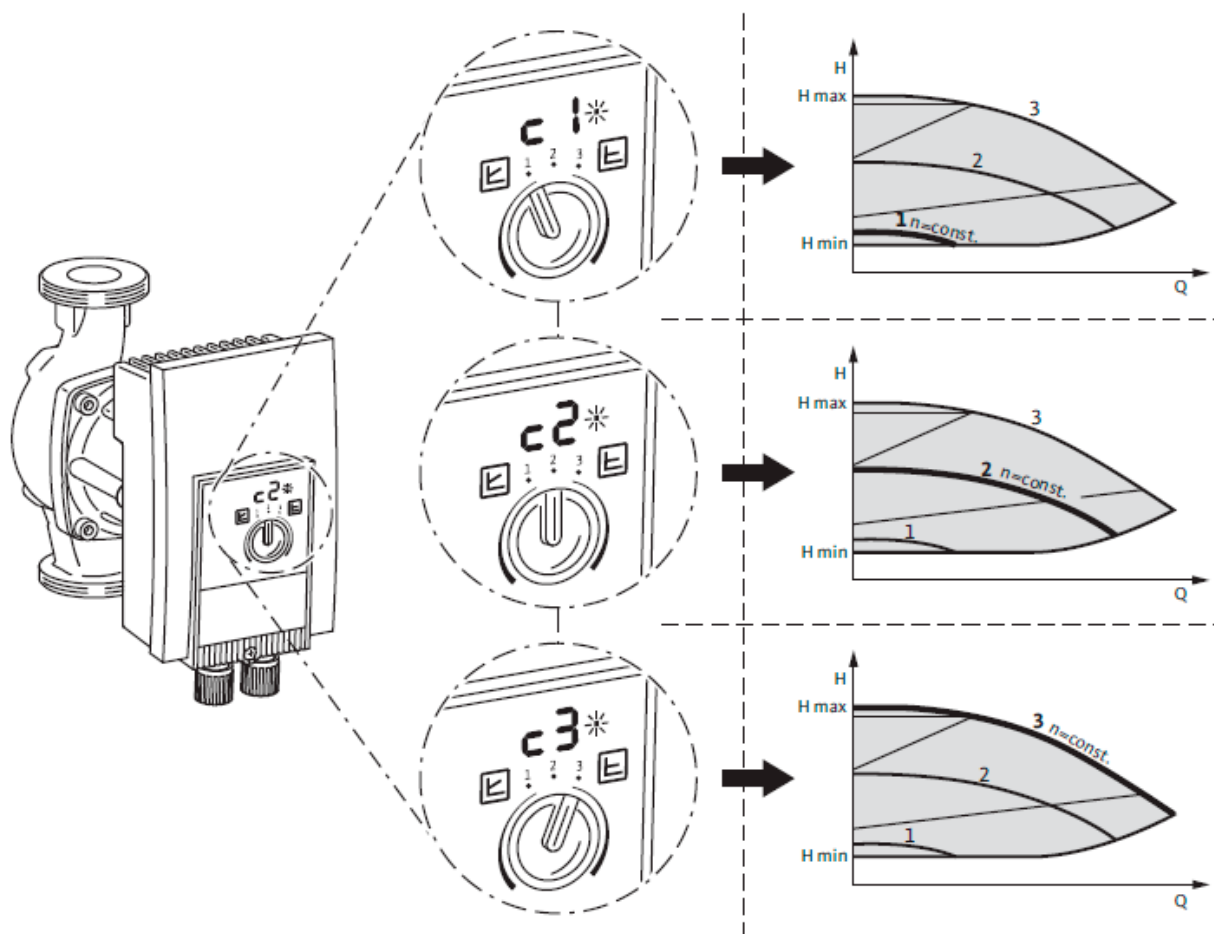

Overview image of the function selector settings. Source: Wilo User Manual for Yonos Para High Flow 2172318-Ed.02/2018-01-Wilo.

LK CONTROL v.3 (ACCESSORIES)

LK Control v. 3 is complete unit for outdoor temperature-compensated heat regulation, adapted and pre-programmed for LK’s Floor Heating System. LK Control consists of a control unit, valve actuator as well as an flow and outdoor temperature sensor. As an option, LK Control can be supplemented with LK Room Unit v.3 for affecting the room temperature of the control unit’s heat curve. This function is similar to a room thermostat but with the possibility of remotely controlling the control unit. LK Room Unit v.3 is often used in open-plan areas where only one room sensor is required.



LK Control v.3.



FLOW DIAGRAM

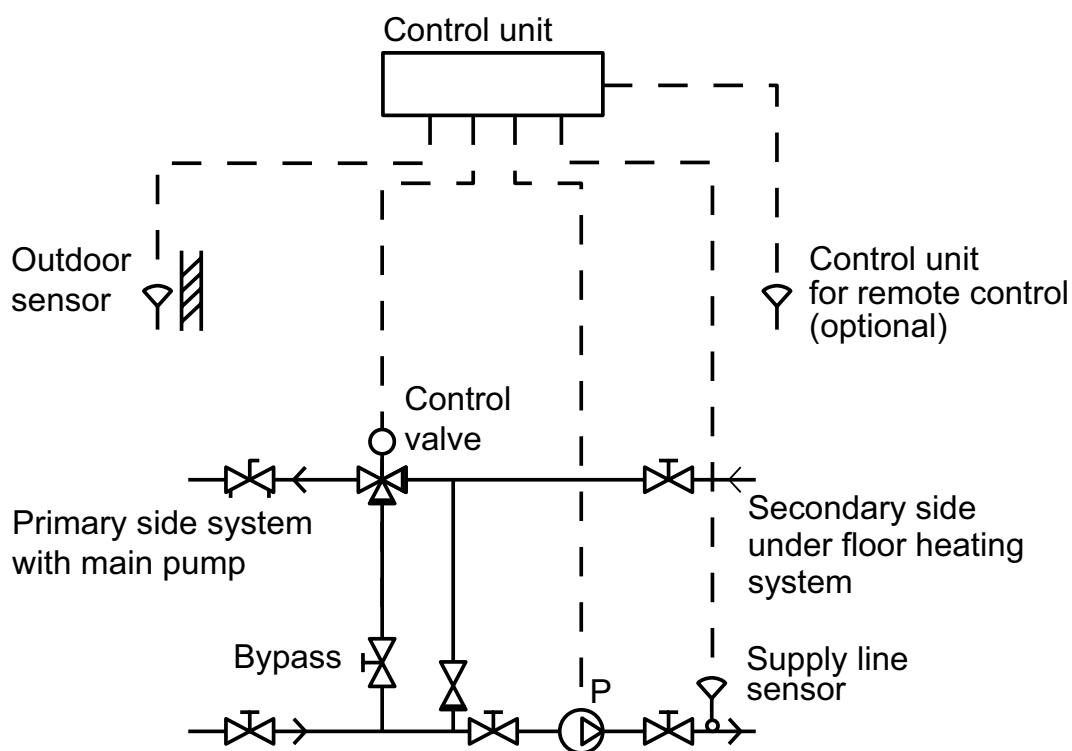

3-way design

Constant flow in the primary and secondary circuit. Used in boiler facilities, heating pumps, etc. where the heater requires a constant flow.

2-way design

Constant flow in the secondary circuit and variable flow in the primary circuit. Used primarily for connection to district heating.

TECHNICAL DATA

Article no.	241 78 24
Maximum operating pressure	0,7 Mpa
Operating temperature secondary	+12 - 63 °C
Ambient temperature	Max 40 °C
Circulation pump	Wilo Yonos Para HF 25/7 180
Voltage	1 fas 230 V DIN IEC 60038 ±10%, 50/60 Hz
Output	Max 120 W
Current	Max 1 A
Protection class	IP X4D
Insulation class	F
Valve capacity	KVS 4,0



DIMENSIONS

