

LK Room Temperature Control ICS.2



DESIGN

LK Room Temperature Control ICS.2 is a control system designed for LK Underfloor Heating. The system is suitable for small, medium or large building installations. LK ICS.2 has been designed to provide high levels of comfort and energy efficient heating systems thanks to its advanced self-modulation technique.

The system consists of LK Receiver ICS.2, LK Room Thermostat ICS.2 and LK Actuators 24 V. Communications between the room thermostat and the receiver can either be wireless or wired.

The receiver is available in versions for 1-channel and 8-channels. The receiver with 1 channel can communicate with 1 room thermostat. The receiver with 8 channels can communicate with 1 to 8 room thermostats. The receiver with 8 channels can combine both wireless and wired communications.

If the system consists of more than one receiver, the units can communicate wirelessly with each other in order for common functions to work. This includes controlling the circulation pump, heat source, the ability to connect the system (LK Webserver) to the Internet.

LK ICS.2 includes a variety of smart features such as adaptive week programming, holiday functions, fire place function, the capability to connect to an remote sensor. By using the LK Webserver accessory, you can control your heating system via the Internet from a mobile phone, tablet or computer. LK ICS.2 can communicate via Modbus protocol RS-485/RTU for connecting to the property controller.

FUNCTION

The room thermostat controls the temperature in each room (zone) via wireless or wired signal transmission to the receiver. The actuators for each room/zone are operated via the receiver.

Self-modulation technique

In order for your underfloor heating to be controlled as energy efficiently as possible, LK ICS.2 works with a self-modulation technique. The self-modulation technique means that the flow in the floor heating circuits is continuously optimised based on the needs of the room and thereby provides better comfort and a more energy efficient and environmentally smarter underfloor heating system compared to systems with traditional ON/OFF technology.

The features the system offers include the following:

- Self-modulation technique
- Access from internet via the LK Webserver accessory*
- Room thermostat in high gloss white, high gloss black or silver grey
- Adaptive week program
- Holiday function
- Logging/analysis function*
- Wired or wireless communication between room thermostat and receiver*
- Valve exercising function
- Pump logics*
- Control of heat source*
- Fireplace function
- By-pass function
- Temperature range limits

* Applies to LK Receiver 8 ICS.2



ASSEMBLY INSTRUCTIONS ICS.2

Requirements

The requirements for a properly functioning underfloor heating system is a weather-controlled regulation system for the supply temperature and a well implemented and documented adjustment of the primary and loop flows.

Assembly of room thermostat and receiver

1. Install the receiver in vicinity of the heating circuit manifold.
2. Install all room thermostat back plates on the inner wall about 1.5 m above the floor. Note which way is up, see arrow in the back plate. Avoid locations that may affect the room thermostat function (e.g. sun light and ventilation).
3. For wired room thermostats, connect 2 x 0.5 mm² cable to the terminal in the back plate marked ICS BOX. Fit the thermostat cable to the green terminal that is enclosed with the wired room thermostat. Press the room thermostat's green terminal block into the receiver's upper terminal strip marked with thermostat symbols.
4. Snap the room thermostat into its back plate.
5. Fit the actuator wire to the terminal block. Press the actuator terminal blocks into the receiver's lower terminal strip marked with the valve/actuator symbol.
NOTE! Maximum of two LK Actuators per terminal (An external terminal is required for three actuators) and a maximum of twelve LK Actuators per receiver 8 and five LK Actuators per receiver 1.
6. Run the actuator cables in the pull relief grooves.

ROOM THERMOSTAT TEMPERATURE MEASUREMENT

In order to achieve accurate room temperature measurement it is important to prevent draft behind the thermostat. If air is sucked in from an adjacent room through the wall box or conduit, the sensor may experience varying temperature depending on wind direction and ventilation. One way to avoid this is by sealing with fireproof insulation like mineral wool / glass wool.

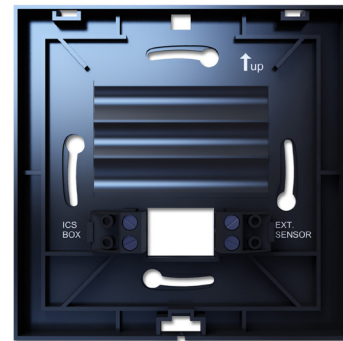

Install the room thermostat's back plate about 1.5 m above the floor. Note the arrow on the back plate indicating which way is up. For the wired room thermostat, the cable is connected from the receiver to the terminal marked ICS BOX. Where necessary, the remote sensor is connected to the EXT Sensor terminal.

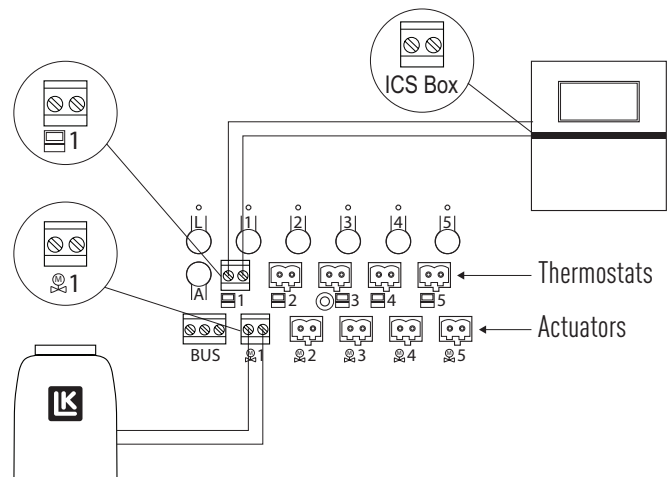

Remember to connect the wired room thermostats, if installed, to the upper terminal strip and the actuators to the lower terminal strip.



SETUP FOR ROOM THERMOSTATS AND RECEIVERS

General

When setting up a system, the constituent receivers must be defined as the Master unit or Slave unit depending only on the size of the system. A network-connected system may consist of a maximum of one Master unit and seven Slave units. In a system with only one receiver, this needs to be programmed as a Master unit. On delivery, the receivers are in Slave mode and ready to be used in a network.

In systems consisting of multiple receiver units, the units can communicate wirelessly with each other in a network. The wireless network enables common functions such as setting System Clock, Holiday Function, By-Pass Function, Pump Control etc. to be set via the settings menu from any room thermostat in the system. The wireless network also enables all units to be controlled and monitored over the internet using the LK Web-server accessory.

If a network is to be established between a number of receiver units, it is recommended that the receiver unit which will comprise the Master unit is positioned as centrally as possible in the system. This is to ensure that the wireless connection with all Slave units is stable. If the distance is too long for a stable connection to be established, the system can be divided into separate subsystems. Or as an alternative solution, each individual receiver unit can be programmed as Master unit, thereby becoming a "stand-alone" system.

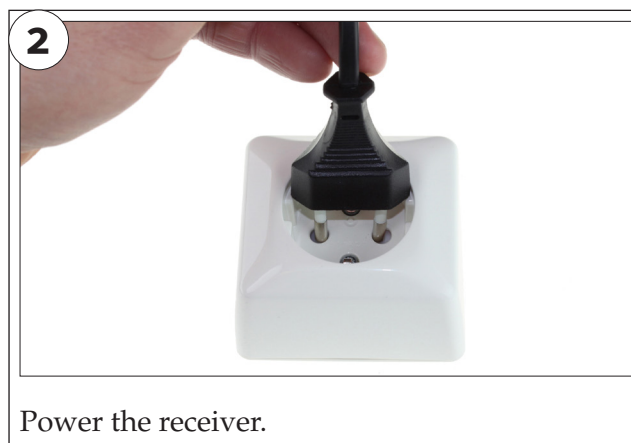

Power the receiver.

Setup for Master unit

Program one receiver unit as Master unit. In systems with multiple receiver units, remember to select a centrally positioned receiver unit as Master unit for a stable connection with its Slave units. Even in systems with just one receiver unit, this unit has to be programmed as Master.

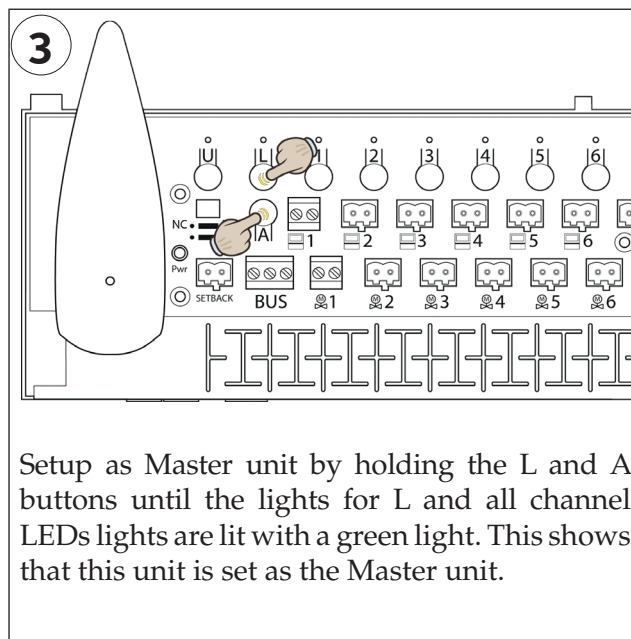

Setup as Master unit by holding the L and A buttons until the lights for L and all channel LEDs lights are lit with a green light. This shows that this unit is set as the Master unit.

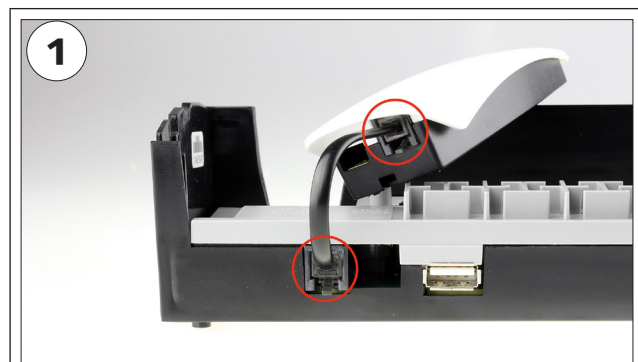

Check to ensure the antenna is connected properly.



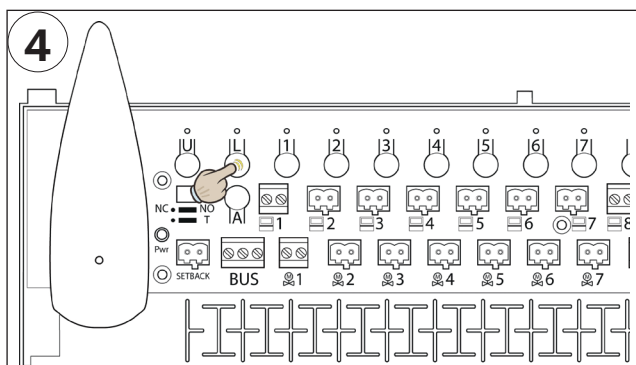

Confirm the setup of the Master unit by pressing the L button once. This turns off all lights and concludes the Master unit setup.

Remember to:
 - mark the unit as Master unit on the label on the unit's cover.

Establishing a wireless network

NB! stages 5-8 are only to be implemented in systems with multiple receiver units that are to communicate in a network.

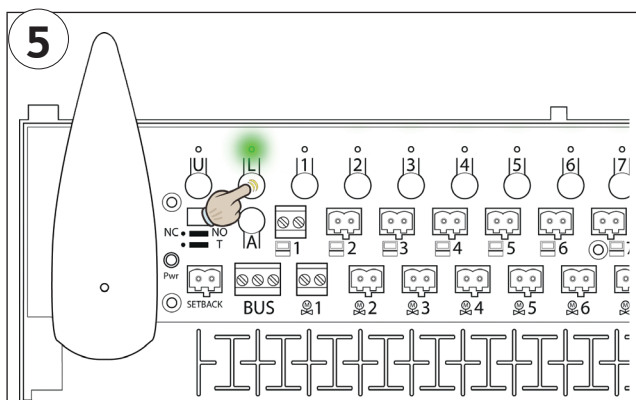

Set the **Master unit** to setup mode by pressing the L button until the light is solid green.

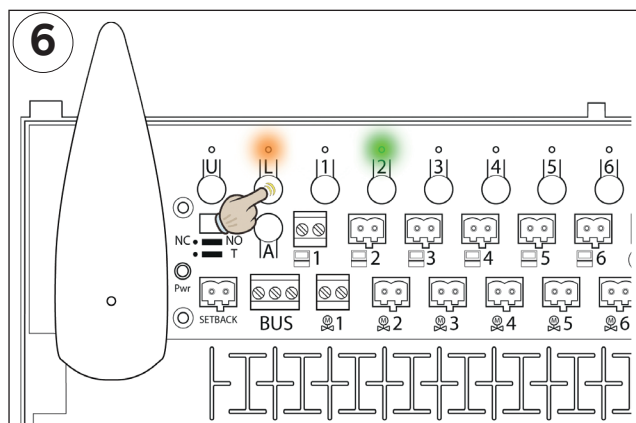

The picture shows a Slave unit that has been allocated order number 2.

Press the L button on the optional Slave unit until the L light turns orange.

The serial number on the Slave unit also appears by one of the lights for channel 2 to 8 lighting green.

If you wish to verify that a receiver unit is setup as well as its serial number on a network, see section *Checking the network* under heading *Troubleshooting*.

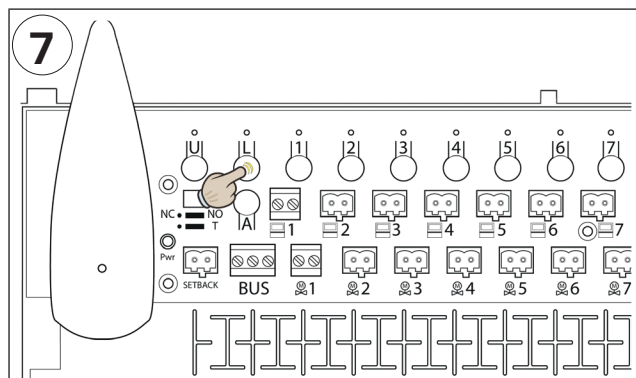

Confirm the setup of the Slave unit by pressing the L button. This turns off all lights in the Slave unit.

 Repeat steps 6 & 7 for other Slave units if installed in the system.

Remember to:
 - ensure that the Master unit's L light lights green continuously during the setup phase for all Slave units.



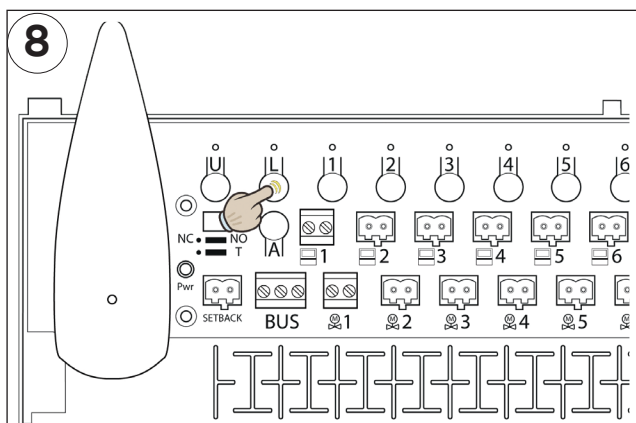

When all slave units have been programmed, the setup is completed by pressing the **Master unit's L button once**.

All the lights on the Master unit should now turn off.

Check that all lights are off on all units to ensure that nothing can interfere with the continued installation of the system.

Setup of room thermostats

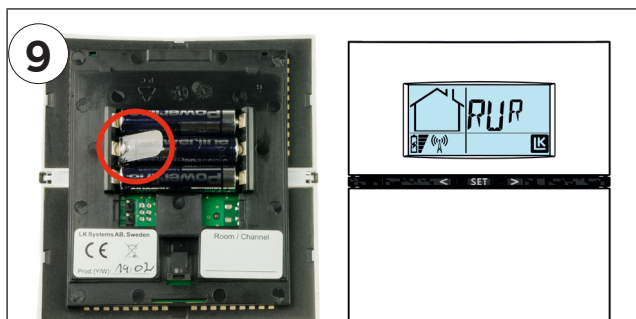

Prepare the system's room thermostats.

Wireless room thermostats:

Remove the plastic insulation from the battery (marked in red circle). The room thermostat display will show RUR.

Wired room thermostat:

Check that the room thermostat is connected to the receiver. The room thermostat display will show RUW.

Note: In general, the installation of the room thermostats is the same whether it is a wireless or wired connection to the receiver.

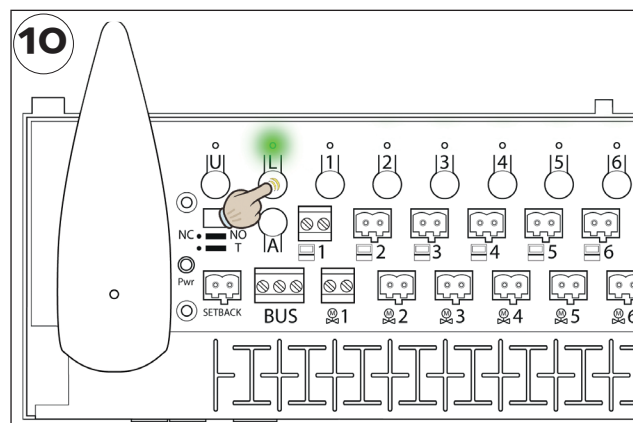

Hold the L button in until the L light is solid green on the receiver that the room thermostats are to undergo the setup process for.

This step prepares the receiver for setup of the room thermostats.

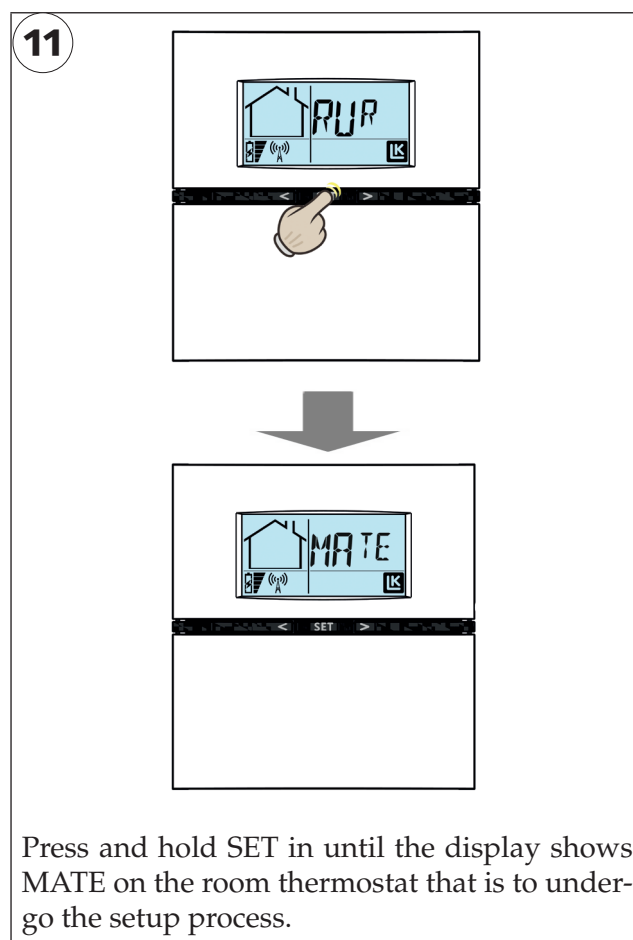

Press and hold SET in until the display shows MATE on the room thermostat that is to undergo the setup process.

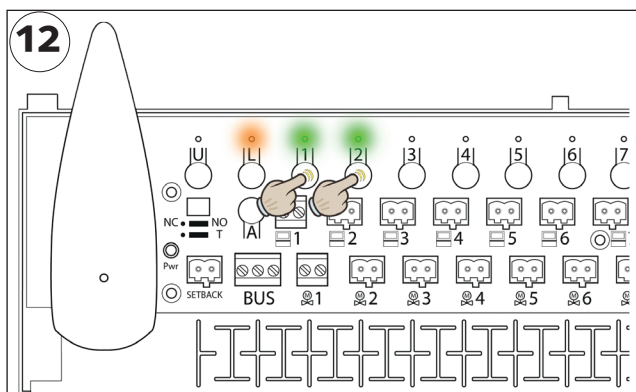

The L light changes to orange and the channel lights change to green.

Choose the channel/channels that the room thermostat is to control by pressing the corresponding channel button (1 - 8). The selected channels flashes green.

Channels already occupied have a solid orange light.

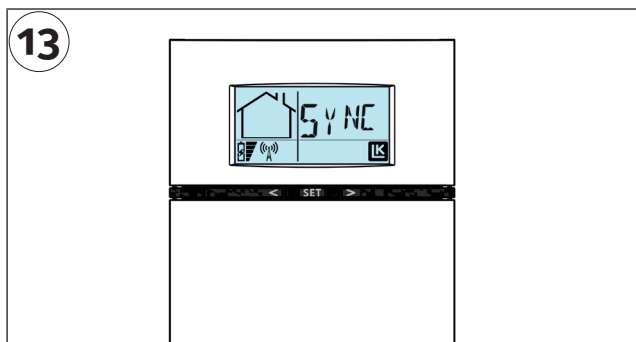

Once all the required channels have finished the setup process, you confirm by pressing the SET button once.

The display will then show SYNC to show that it is synchronising with the receiver (this may take a while).

If the room thermostat takes a long time to synchronise, this synchronisation process can be sped up by pressing the SET button once.

Selected channels (actuator outputs) will be shown in the room thermostat's display with their channel number (1-8).

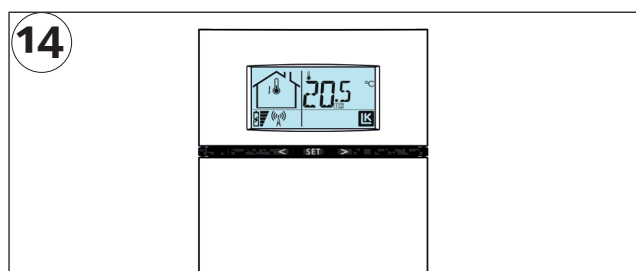

Once synchronisation is complete, the room thermostat shows standard mode with room temperature and other information. This confirms that the setup is complete.

Worth knowing:

The channel/s (actuator outputs) for which the room thermostat has been programmed are shown in the display with channel number (1-8) under the room temperature display. The display's house symbol shows the receiver unit for which the room thermostat is programmed to with an order number (1-8).

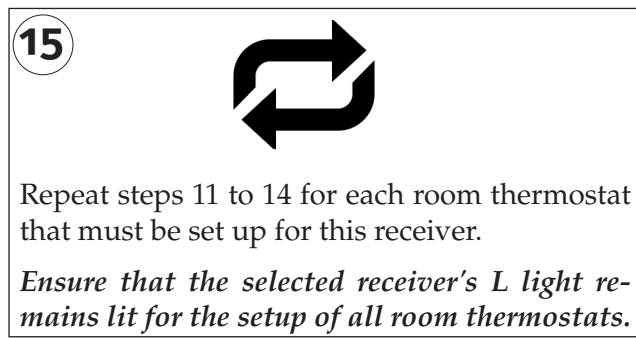

Repeat steps 11 to 14 for each room thermostat that must be set up for this receiver.

Ensure that the selected receiver's L light remains lit for the setup of all room thermostats.

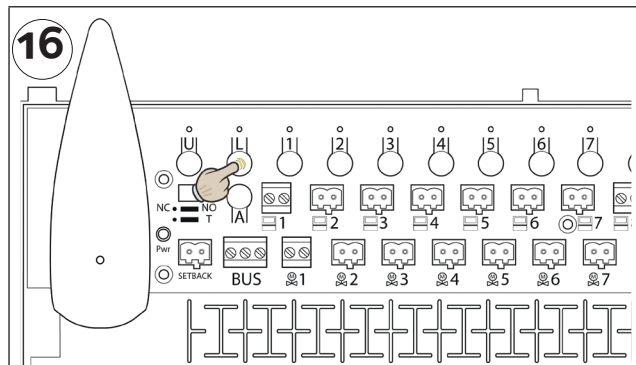

When all the room thermostats have finished the setup process for the receiver in question, the setup process is completed by pressing the L button. Ensure that the L light goes out.

Repeat steps 10 to 16 for other receivers (slaves) if installed in the system.

For settings/adjustments of the room thermostat or receiver, see more under section **LK Receiver and Room Thermostat.**



REMOTE CONTROL AV LK RECEIVER 8 ICS.2

There are various solutions for remote control of LK Room Temperature Control ICS.2. The various options available for remote control of LK Room Temperature Control ICS.2 is described below.

Simple remote control of LK ICS.2

LK Receiver 8 ICS.2 can easily be managed by remotely controlled by closing its two-pole setback contact. The simplest way to close the setback contact is via a circuit breaker/relay or, alternatively, via a GSM module which is controlled by a mobile phone. When the setback contact is closed, the room control reduces the room temperature for all room thermostats to a lower temperature, the so-called setback temperature. The preset setback temperature is 12° C, but it can be changed in the respective room thermostat.

LK Webserver



Using the LK Webserver accessory, you can easily control your underfloor heating system remotely via a mobile phone, tablet or computer. The webserver's user interface is easy to manage and provides a good overview of the underfloor heating system. Alarms, if any, are displayed via the alarm icon, and information about the alarm is received in plain text.

LK Webserver can also be used as a wireless communications bridge. This function is used when Internet in the property is not available at the underfloor heating installation's receiver. A wireless communication can then be established between two LK Webservers. The first web server is installed at the underfloor heating installation's receiver and the other one at the building's Internet connection.

The web server located at the receiver will now operate as a wireless communications bridge to the Webserver with an Internet connection.

More information about LK Webserver is available on our website, www.lksystems.se.

Building automation **Modbus**

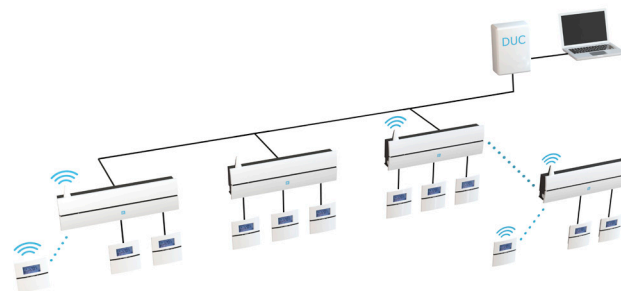

LK Room Temperature Control ICS.2 can be integrated into a building's comprehensive control system. LK ICS.2 communicates via the Modbus protocol RS485/RTU.

LK Room Temperature Control ICS.2 communicates "point to point" with the network's BMS.

LK Systems provides on request documentation that describes the communication protocol, which makes it possible to control/read all of the system's features via Modbus.

MODBUS ICS.2 TECHNICAL DATA

Protocol	Modbus RTU via RS-485
Modbus address of the unit	<u>1</u> -247
Speed (Baud rate)	9600, 19200, <u>38400</u>
Parity	Odd, Even, <u>None</u>
Number of Stop bits	<u>1</u> , 2
Number of Data bits	8

Default setting is underlined



LK RECEIVER 8 ICS.2



LK Receiver 8 ICS.2

Functional Description

LK Receiver 8 ICS.2 has 8 channels which means that up to 8 LK Room Thermostats ICS.2 can be assigned/connected to the receiver unit.

The Receiver collects data from each room thermostat and sends control signals to the LK Actuators. As the communication between the receiver and actuators is via a cable, the receiver should be placed close to the underfloor heating manifold.

Switch NO/NC function

If necessary, the receiver can be adapted to currentless closed (NC) or currentless open (NO) actuators. This adjustment is done by moving the NC/NO jumper to the correct position as shown in the picture below.

Restart the receiver after the change.

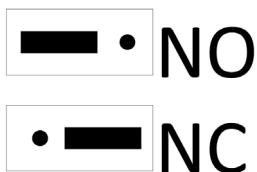

MEM input

The receiver is fitted with a MEM input (USB type A) that is primarily used when you need to log into the system. Measurement data is sent to the LK ICS MEM Stick once a minute. It is possible to easily check/analyse the system using measurement data and the LK ICS.2 Analyzer software.

1. Insert the LK ICS MEM Stick into the MEM input.
2. Information transfer is completed when the green U light lights continuously.
3. Remove the LK ICS MEM Stick when logging is complete.
4. Transfer the information to the LK ICS.2 Analyzer to see how the measurement data has been logged.

The LK ICS MEM Stick is an accessory that can be ordered through LK’s retail dealers. The LK ICS.2 Analyzer can be downloaded free of charge from LK’s website, www.lksystems.se.

The text file SYSINFO.TXT is among the information that is saved. This file can be viewed in a computer without special software and contains system information that can be of assistance during troubleshooting. Program version 2.00 provides a summary of the receiver zones as well as help texts which interpret the signal strength to the installed units.

Setback input

The unit is equipped with an input for centralised temperature reduction via, for example, a GSM Switch, which can be operated with a mobile phone. A closed contact provides a centralised reduction of all room thermostats in the system. When enabled, all room thermostats show EXT in their displays, and the temperature is lowered to 12 °C for all rooms/zones. The temperature can be adjusted; read more in section *Settings/Functions*.



LK RECEIVER 8 ICS.2, OVERVIEW

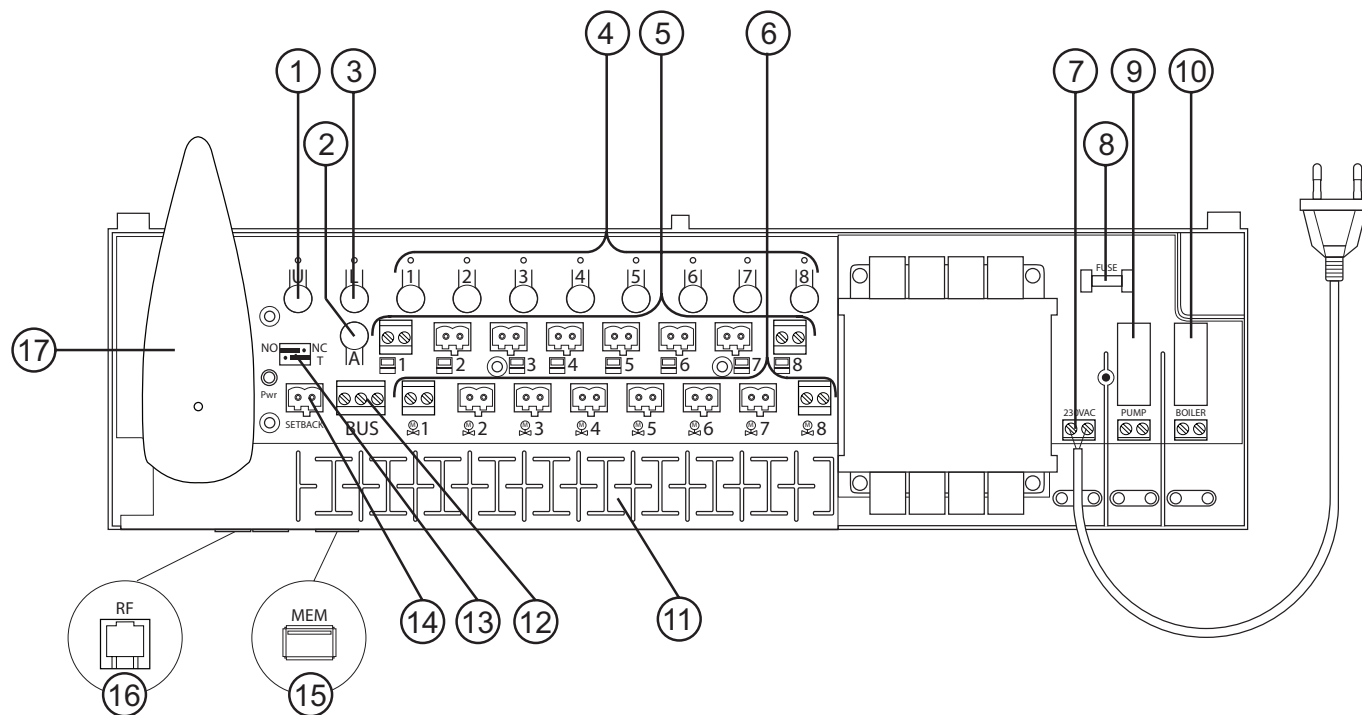

LK Receiver 8 ICS.2

No.	Name	Description
1	U button	Used if the unit software needs updating.
2	A button	Used in combination with other buttons to enable alternative functions.
3	L button	Enables/disables setup mode.
4	Button 1-8	Buttons 1-8 are used to select the required channel for setup.
5	Thermostat input	Thermostat input for connecting wired LK Room Thermostats ICS.2 W (Min. cable area 2 x 0.5 mm ²).
6	Actuator output	For connection of LK Actuator 24V (max 2 actuators per output).
7	Power supply	The unit is connected to 230 V AC via a factory-installed cable.
8	Fuse	Fuse 230 V AC, T200mA. Cut the power supply before changing the fuse!
9	Pump relay	Potential free relay contact for control of the circulation pump.
10	LK Relay 1 ICS.2	Potential free relay contact for control of the heat source.
11	Strain relief	Groove for relief of cables.
12	Modbus connection	For connection of LK Webserver or connection of BMS (min. cable area 3 x 0.5 mm ²).
13	Jumpers: Actuator type NO/NC Modbus termination T	NOTE! Restart the receiver after changing the jumper. - For adaptation of the unit to NO or NC actuators. - Terminated on delivery in mode T. Disconnect the termination resistance of intermediate units in a Modbus circuit by moving the strapping to the left.
14	Setback input	A closed contact provides centralised lowering of all room thermostats in the system.
15	MEM input	For logging of measurement data or updating software.
16	Antenna input	For connecting the unit's antenna.
17	Antenna	For communication with the wireless room thermostats and the receivers when they are connected in a network. LK Antenna Cable ICS.2 allows you to extend it to 10 metres.



Pump Relay

Receiver 8 has a potential-free pump relay for controlling the system's circulation pump, for example a pump in a shunt unit. The relay is located under the protective cover, protecting from dangerous voltage.



NOTE!
Cut all incoming voltage to the unit before opening the protection cover. Remember that the relay for pump and heat source are powered from an external power supply which must also be cut.

Note that the relay contact is potential-free which means that the relay contact must be powered from an external source (NOTE: Not from the receiver's power supply). The pump activates the heat source about 6 minutes after any channel has called for heat. When the relay is enabled the Pump LED lights. The pump is run once a day to prevent the pump from jamming during long periods of downtime, e.g. summertime.

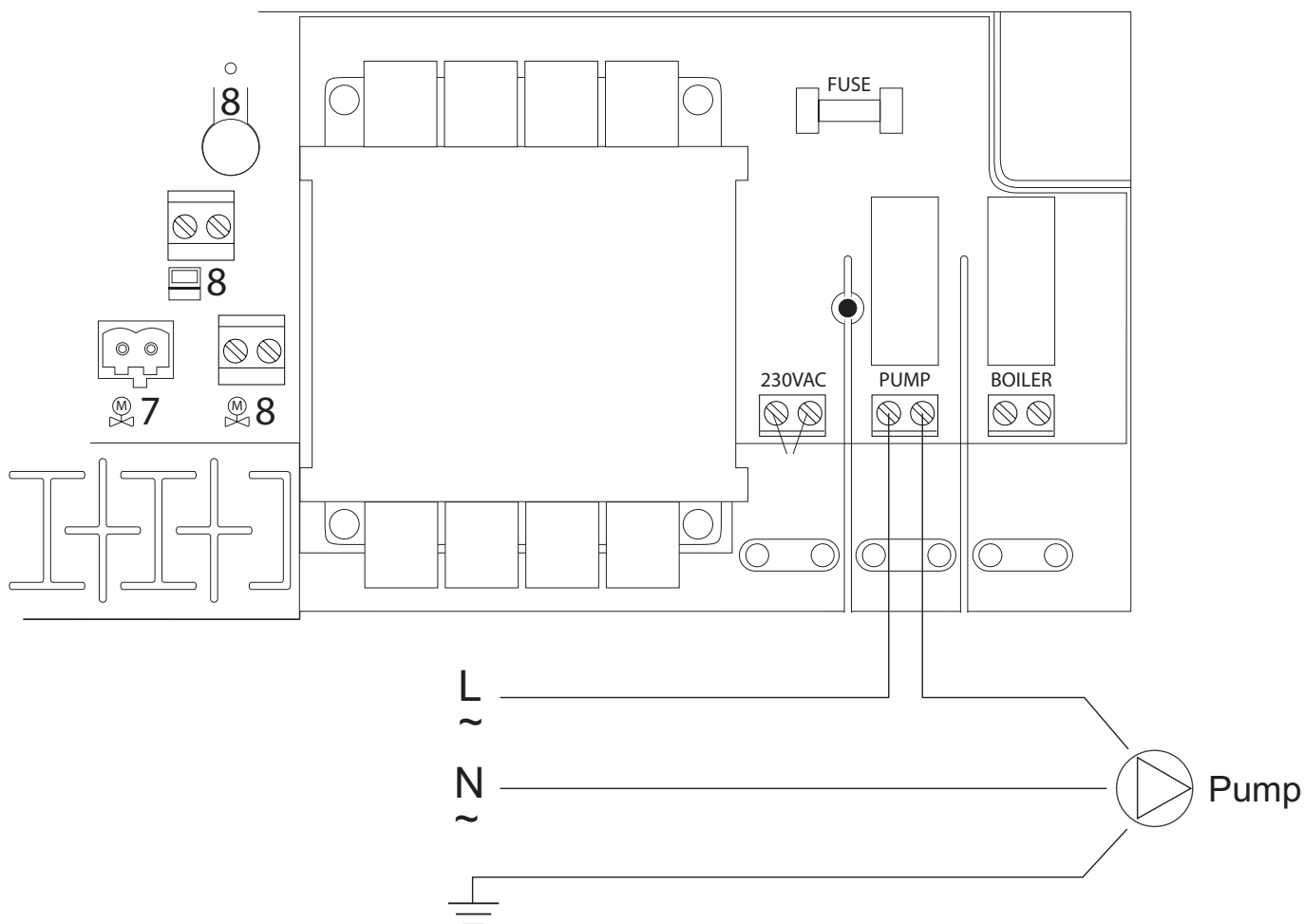

Wiring diagram for connecting the pump to receiver 8.



Boiler Relay

It is possible to control the system's heat source via the unit's boiler relay. The relay is located under the protective cover, protecting from dangerous voltage.



NOTE!
Cut all incoming voltage to the unit before opening the protection cover. Remember that the relay for pump and heat source are powered from an external power supply which must also be cut.

Note that the relay contact is potential-free which means that the relay contact must be powered from an external source (NOTE: Not from the receiver's power supply). The relay activates the heat source about 6 minutes after any channel has called for heat. When the relay is enabled, the Boiler LED lights.

See the circuit diagram below.

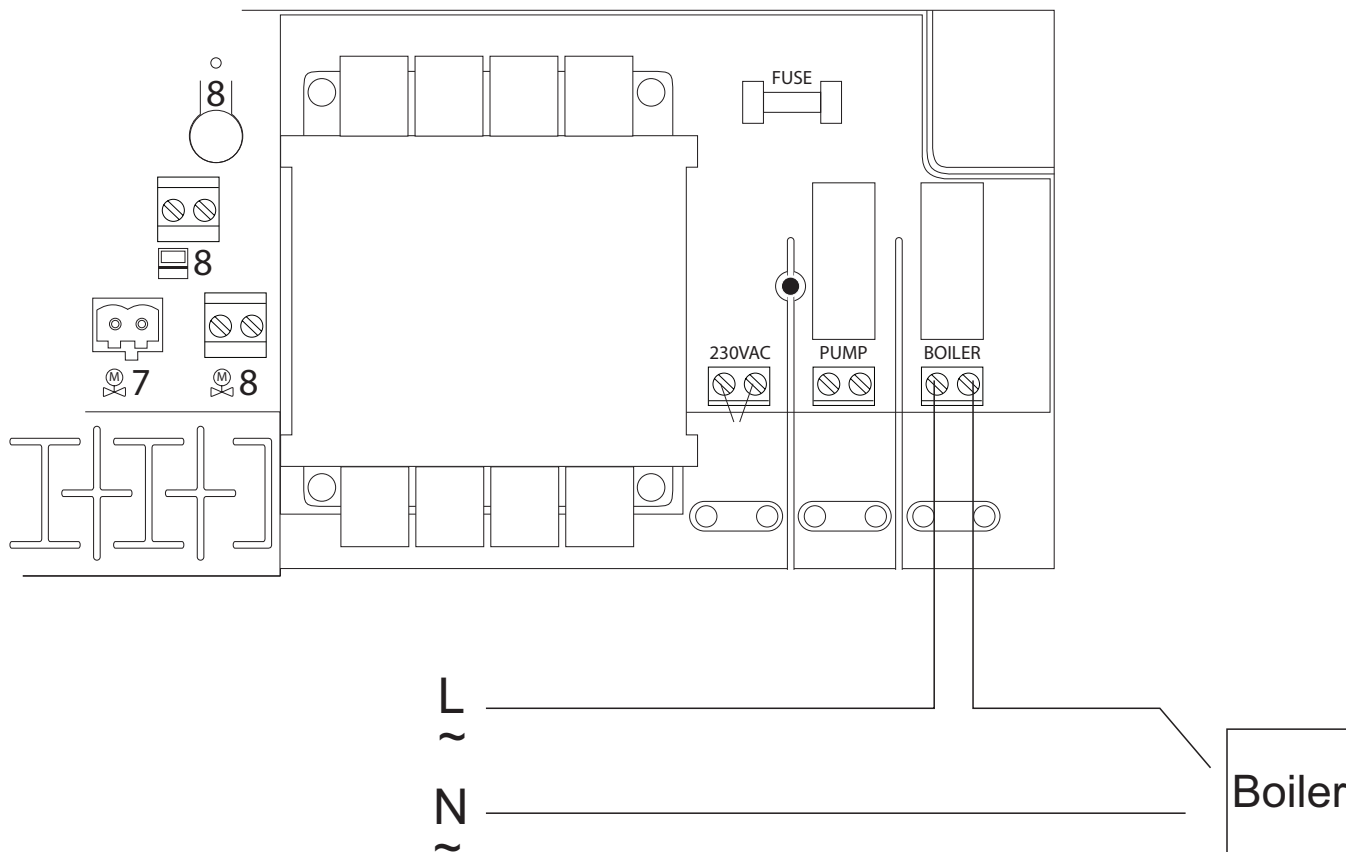

Wiring diagram for connecting the heat source to receiver 8.



LK RECEIVER 1 ICS.2

The LK Receiver 1 ICS.2 has 1 channel which means that maximum 1 LK Room Thermostats ICS.2 can be assigned/connected to the unit.

The Receiver collects data from the room thermostat and sends control signals to the LK Actuators. As the communication between the receiver and actuators is via a cable, the receiver should be placed directly adjacent to the underfloor heating manifold.

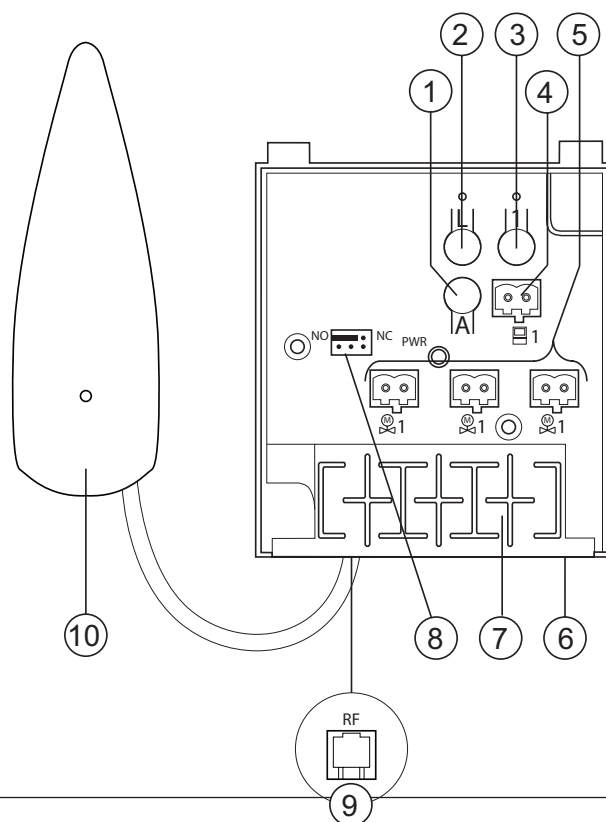

No.	Name	Description
1	A button	Used in combination with other buttons to enable alternative functions.
2	L button	Enables/disables setup mode.
3	Button 1	Button 1 is used to select the required channel for setup.
4	Thermostat input	Thermostat input for connecting one wired room thermostat W ICS.2 (min cable size 2 x 0.5 mm ²).
5	Actuator output	For connection of LK Actuator 24V (max 2 actuators per output and a total of 5 per receiver unit 1).
6	Power supply	The unit is connected to 230 V AC via the enclosed external power supply.
7	Strain relief	Groove for pull relief of cables.
8	Actuator type NO/NC	Actuators which are connected to the unit, NO or NC actuators are selected in the top row. (The bottom row is not used in Receiver 1)
9	Antenna input	For connecting the unit's antenna.
10	Antenna	For communication with the wireless room thermostats and the receivers when they are connected in a network. LK Antenna Cable ICS.2 allows you to extend it to 10 metres.

Differences between Receiver 1 and 8

Model	Thermostats / zones	Setback input	Modbus	Note
Receiver 1	1	No	No	Indications 2-8 are not displayed
Receiver 8	1 - 8	Yes	Yes	



LK ROOM THERMOSTAT ICS.2

Functional Description

LK Room Thermostat ICS.2 is available as a version where the communication between the room thermostat and the receiver is wireless as well as in a wired version where the communication between the room thermostat and the receiver takes place via a two-wire cable. In order to distinguish between the room thermostats, the wireless room thermostat is referred to as RF and the wired version as W.

It is possible to combine both wireless and wired communications in LK Receiver 8 ICS.2.

The room thermostat is installed in the room/zone it is supposed to control. The room thermostat display shows the current room temperature in the normal view. Set/required temperature is displayed when you press the left arrow or right arrow once. If you press again, this changes the temperature in steps of 0.5 degrees.

The room thermostat is fitted with an internal temperature sensor that senses the room temperature. It is possible to fit the room thermostat with a LK External Sensor ICS.2. The external sensor is normally installed on the floor whereby the room thermostat controls the floor temperature or the floor temperature in combination with the room temperature. Read more under section **Remote sensors**.

The room thermostat has a clock function that allows you to lower the night temperature as part of a week program. The program starts/stops by default when the scheduled start/stop times occur. You can also enable the thermostat's adaptive control, which means that the system is self-learning. Following an enabled adaptive function, the thermostat calculates when the heat needs to start in order to achieve the right temperature at the required time. Temperature increases are influenced by the adaptive function. Temperature setback occurs after the programmed stop time. Read more under section **Week program** heading about how the function is activated.



The LK ICS.2 has a holiday function that can be enabled from any thermostat in the system. The holiday function allows lowering the temperature for a longer time in an easy way, such as during a holiday. When enabled, the function lowers the temperature to 12 °C for all room thermostats. Read more under section **Holiday function**.

If necessary, you can lock the room thermostat to prevent unauthorised users from changing the room thermostat settings. Read more under section **Button lock**.

There is also a function that allows you to restrict the room thermostat setting temperature. In apartment buildings, for example, where it is desirable to limit the residents' room temperature in a given range, such a minimum of 18 °C to max. 22 °C. Read more under section **Temperature range limits**.

Description of the room thermostat functions



Left arrow = decrease value (1)
 SET = confirm/access of menus (2)
 Right arrow = increase value (3)



DESCRIPTION OF DISPLAY

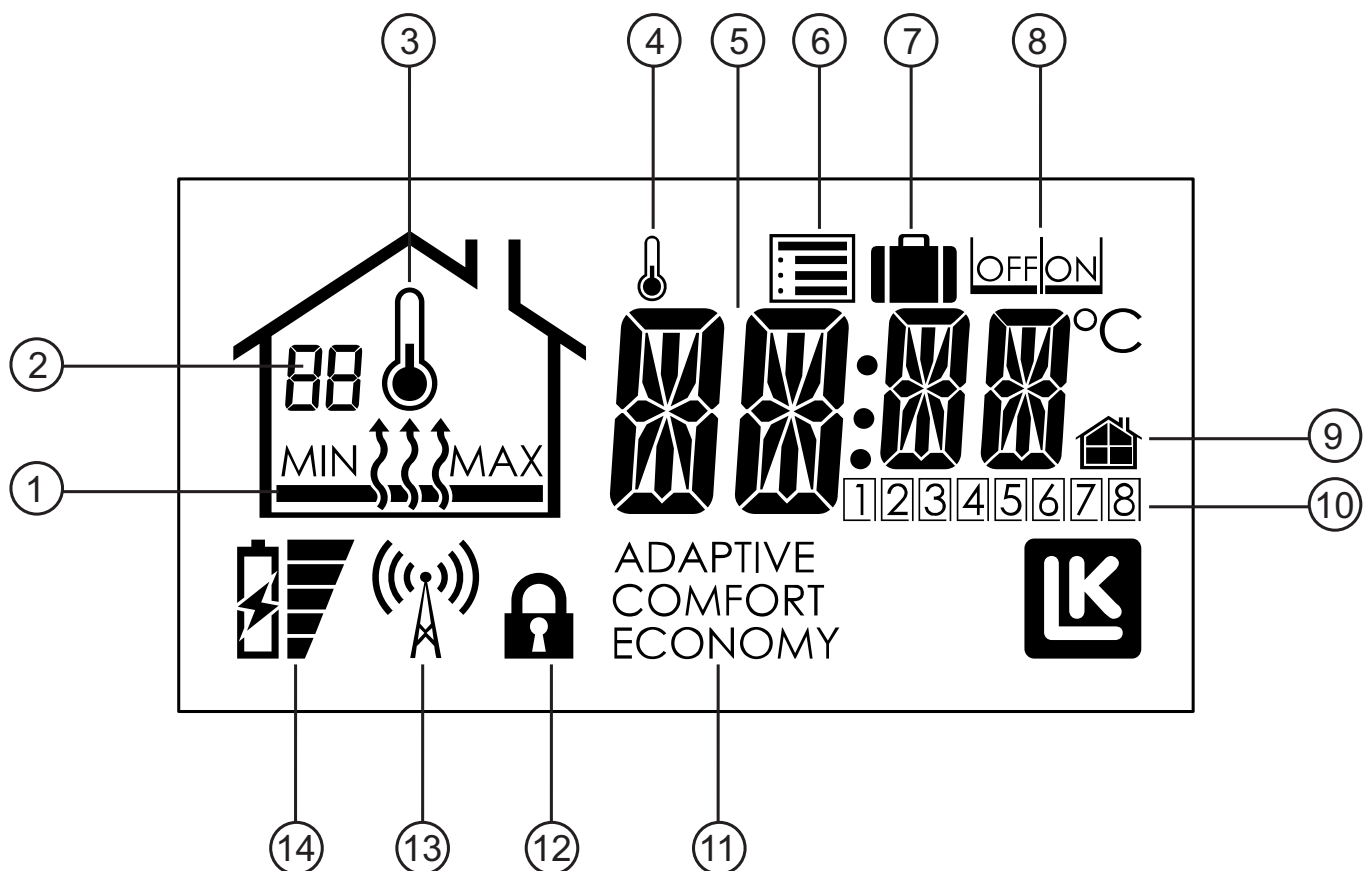



1. Heat on/off and MIN and MAX limit
2. Number on receiver and error code
3. Room temperature measurement enabled
4. Indicates constantly disconnected week program
5. Temperature indication
6. Setup menu
7. Holiday function
8. OFF/ON option
9. Local/general setting
10. Controlled channel/weekday
11. Operation Mode
12. Button lock symbol
13. Communication symbol*
14. Battery indicator *

* Applies to wireless communications



DESCRIPTION OF THE ROOM THERMOSTAT'S MENUS/SETTINGS

There are a number of abbreviations under the room thermostat setup menu . The table below shows the abbreviation and its meaning.

The room thermostat setup menu is accessed by holding down the SET button until  flashes, confirm with SET. Select the required menu using the right arrow or left arrow. Confirm with SET. Adjust the required value and confirm with SET. The room thermostat will automatically return to normal operation after about 1 minute. Alternatively, press and hold SET for 5 seconds to return to normal view. Each menu option/function is described in detail after the table.

Abbreviation shown in display	Meaning	Brief explanation of menu options
SET	Setback, central temperature reduction	Sets the required temperature for the system when the external actuation is made via the SETBACK input on receiver 8. Preselected temperature 12 °C.
Holi	Holiday function	Sets the required temperature when holiday function is enabled. Preselected temperature 12 °C.
WKMD	Week mode, week program, weekday/weekend	The unit's week program can be used for all days of the week (1-7) or for weekday and weekend (1-5 and 6-7)
ECO	Economy, night setback temperature	Setts the required night setback temperature. Preselected temperature 18 °C.
COMF	Comfort, normal temperature	Sets the required normal temperature. Preselected temperature 20 °C.
WKEV	Week events, start/stop times for the week program	Setting the start/stop times for night setback. The unit can handle two deactivations and two activations per day.
WKPG	Week programs, enable/disable	Adaptive week program. Option on or off. Default off.
SYSC	System clock	Sets the system time and day of the week. 1 = Monday. Set value applies to all units in the system.
SYSD	System date, system calendar	Sets year, month and day. Set value applies to all units in the system.
SENM	Sensor mode, setting sensors	You can specify the function of the remote sensor for the connected external sensor. Select from only room temperature, only floor temperature, room temperature combined with minimum floor temperature and room temperature in combination with maximum floor temperature.
ADPT	Adaptive function on/off	Activation of adaptive start times following enabled week program. Default off.
BKLT	Backlight on/off	Activation of display backlighting. Option on or off.
LOCK	Button lock on / off	Button lock. The buttons on the unit can be locked to prevent unauthorised users from changing the room thermostat settings.
RFST	Radio Frequency Strength Checking of the signal strength	Using this function it is possible to check the signal strength between a wireless room thermostat and the receiver.
FIPL	Fire Place Function Fire place function on/off	The function is designed to be used when a high temperature comfort is required for the floor even though the room is heated from another source, such as a wood burning stove. Option on or off. Default off.
BYPS	Bypass	It is possible for one or more room thermostats to open their circuits when the other room thermostats have closed theirs. The function is primarily designed for use when the heat source comes from a heat pump. The function default is off.
RATR	Restricted allowed temperature range Temperature range limits	It is possible to limit the room thermostat's adjustable temperature range. The function can be used in an apartment building, for example, where the residents are given the opportunity to control their room temperatures within a temperature range of, for example, 18 to 22 °C.



SETTINGS/FUNCTIONS

Setback (central temperature reduction)

The LK Receiver 8 ICS.2 is fitted with a *setback* input. Enabled contact (closed contact) gives a temperature setback for the entire system. The *setback* temperature is pre-set to 12 °C. The temperature can be changed for individual room thermostats as follows:

1. Press *Set* until  flashes, confirm with *Set*.
2. Press the right arrow until *SET* (Setback) appears in the display, confirm with *Set*.
3. Select the temperature using the left /right arrow, confirm with *Set*.

Repeat the above for the other room thermostats in the system.

Holiday function – set the temperature

The room thermostat is fitted with a 'holiday function' which means that you can activate a general temperature reduction for the system for 1-99 days from any room thermostat. The temperature setback is factory pre-set to 12 °C room temperature.

The temperature can be changed for individual room thermostats as follows:

1. Press *Set* until  flashes, confirm with *Set*.
2. Press the right arrow until *Holi* (Holiday) appears in the display, confirm with *Set*.
3. Set the required temperature using the right/left arrow, confirm with *Set*.



Repeat the above for the other room thermostats in the system.

NOTE!

Following an activated function, the risk of freezing must be considered for the vulnerable zones of the underfloor heating system, such as within the garage door or other weather exposed edge zones.

Holiday function – enable

The function is enabled from any room thermostat as follows:

1. Press *Set* until  flashes.
2. Select  using the right arrow, confirm with *Set*.
3. Select *ON*, confirm with *Set*.
4. Select *ON/OFF* using the right/left arrow, confirm with *Set*.

The room thermostat now displays how many days are left. The days count down accordingly. When the days reach zero, the room thermostats return to normal operation.

NOTE!

Note that the countdown starts when the activation was made which means the countdown takes place on the next day at the same time.

Holiday function – disable

The function is disabled from any room thermostat as follows:

1. Press *Set* once.
2. Select *OFF*, confirm with *Set*.
3. The room thermostat switches to normal view.

Other room thermostats automatically switch to normal view within about five minutes.



Week program

The unit is fitted with a week program. The week program switches between either *Comfort* (day temperature) or *Economy* (night setback). The times for each temperature can be set as stated in the options below. The system can also adjust the start time to ensure that the correct temperature is reached at the right time with the adaptive function connected (self-learning). The week program is not activated by default on delivery.

Week program – enable

The week program is enabled, as follows:

1. Press *Set* until  flashes, confirm with *Set*.
2. Press the right arrow until *WKPG* (Week Program) appears in the display, confirm with *Set*.
3. Select *ON/OFF* using the right/left arrow, confirm with *Set*.
4. Repeat the above for the other room thermostats that are to follow the week program.

NOTE!

The system clock must be set correctly for this function to work properly.

Week program – weekday/weekend

The unit can handle either a program for all days of the week (1-7) or a program for weekdays & weekends (1-5/6-7).

Select the program as follows:

1. Press *Set* until  flashes, confirm with *Set*.
2. Select *WKMD* (Week Mode) using the right/left arrow, confirm with *Set*.
3. Select either 1-7 or 1-5/6-7 using the right/left arrow, confirm with *Set*.

The above setting applies to the individual room thermostat.

Week program – temperatures

The units are delivered by default with the following values:

Comfort = 20 °C

Economy = 18 °C

Change the temperatures, as follows:

1. Press *Set* until  flashes, confirm with *Set*.
2. Select *Eco* for night setback temperature, confirm with *Set*.
3. The temperature flashes, change the temperature using the right/left arrow, confirm with *Set*.

Repeat the above but select *Comfort* for setting the day temperature.

NOTE!

The above setting only applies to that specific room/thermostat. If you want the same temperature for all room thermostats, repeat the above steps for the other room thermostats.

Week program – start/stop times

The unit can handle two events per day, i.e. the time the unit is to switch between day (*Comfort*) and night (*Economy*).

Follow these steps to set the time:

1. Press *Set* until  flashes, confirm with *Set*.
2. Select *WKEV* (Week Event) using the right/left arrow, confirm with *Set*.
3. The time to start 1 of Economy flashes, set the required time using the right/left arrow, confirm with *Set*.
4. The time to stop 1 of Economy flashes, set the required time using the right/left arrow, confirm with *Set*.
5. The time to start 2 of Economy flashes, set the required time using the right/left arrow, confirm with *Set*.
6. The time to stop 2 of Economy flashes, set the required time using the right/left arrow, confirm with *Set*.

The above setting applies to the individual room thermostat.



Week program – adaptive function

The system has an adaptive function which means that the system learns the level of thermal inertia in the room and adjusts the start time to ensure the temperature is reached at the required start time (from *Economy* to *Comfort*).

The unit comes with a disabled adaptive function, the function is enabled as follows:

1. Press *Set* until  flashes, confirm with *Set*.
2. Press the right arrow until *AdPt* (Adaptive) appears in the display, confirm with *Set*.
3. Select *ON/OFF* using the right/left arrow, confirm with *Set*.

The function starts following the next change from *Economy* to *Comfort*.

NOTE!

The above setting only applies to that specific room/thermostat.

Week program - disconnect the program temporarily

If you want, you can disconnect the week program temporarily for the individual room thermostat using any room thermostat. If you want, using any room thermostat, you can disconnect the week program temporarily for the individual room thermostat.

The week program is temporarily disconnected, as follows:

1. Increase/decrease the temperature using the right/left arrow.
2. The temperature starts to flash.
3. The temporary increase/decrease is enabled when the temperature stops flashing.
4. The display shows neither *Comfort* or *Economy* when the temporary increase/decrease is enabled.

The temporary disconnection of the week program disappears when the program switches between *Economy/Comfort* next time.

Alternatively, press *Set* for 5 seconds to return to the week program.

Time & date

The unit is fitted with a system clock. In order for the week program to work, the unit's system clock must be set. This can be done from any room thermostat in the system. The set time applies to all room thermostats in the system.

Set the system clock, as follows:

1. Press *Set* until  flashes, confirm with *Set*.
2. Press the right arrow until *SySc* (System Clock) appears in the display, confirm with *Set*.
3. Hours/minutes flashes, set the time by using the right/left arrow, confirm with *Set*.
4. Weekday starts flashing, select using the right/left arrow, (1 = Mon, 7 = Sun) confirm with *Set*.

Set the year and date as follows:

1. Press *Set* until  flashes, confirm with *Set*.
2. Press the right arrow until *SYSD* (System Date) appears in the display, confirm with *Set*.
3. Year flashing, set the Year by using the right/left arrow, confirm with *Set*.
4. Month flashing, set the Month by using the right/left arrow, confirm with *Set*.
5. Date flashing, set the Date by using the right/left arrow, confirm with *Set*.

Backlight display – activation

The room thermostats have a backlit display that lights up when you press any of the buttons. For wireless room thermostats, the backlight is off by default.

This function can be enabled as follows:

1. Press *Set* until  flashes, confirm with *Set*.
2. Press the right arrow until *BKLT* (Back Light) appears in the display, confirm with *Set*.
3. Select *ON/OFF* using the right/left arrow, confirm with *Set*.
4. The above setting only applies to the individual room thermostat.

NOTE!



Remember that an activated backlight affects battery life.



Button lock

It is possible to lock the room thermostat buttons to prevent unauthorised users from changing the room thermostat settings.

The button lock is enabled as follows:

1. Press *Set* until  flashes, confirm with *Set*.
2. Press the right arrow until *LOCK* appears in the display, confirm with *Set*.
3. Select *ON/OFF* using the right/left arrow, confirm with *Set*. The padlock icon  appears in the display.
4. The above setting only applies to the individual room thermostat.

When the lock is enabled, you unlock the room thermostat as follows:

1. Press all three buttons simultaneously for at least 20 seconds.
2. The padlock icon disappears and the room thermostat reopens.

Checking signal strength*

Before the system is put into operation the first time, the signal strength should be controlled to ensure that all room thermostats are within transmission range.

Follow these steps to check the signal strength:

1. Press *Set* until  flashes, confirm with *Set*.
2. Press the right arrow until *RFST* (Radio Signal Strength) appears in the display, confirm with *Set*.
3. Read off Note the value. Read the value. Return to the setup menu using *Set*.
4. Repeat points 1 to 3 for other room thermostats installed in the system.

You can check the signal strength for all units simultaneously to save time.

* Only for thermostat-RF.

Signal strength	Comment
0-20	No signal
21-40	Substandard
41-60	Weak
61-80	Good
81-100	Excellent

Fireplace function

This function is designed to be used when you require high comfort on your floor even though the room is already heated, for example, when you fire up a wood burning stove. When this function is enabled, it controls the room thermostat at 50 % heat (default) to maintain heat in the floor surface. The controlled output is adjustable from 5-100%. The operation is time controlled over 1-99 h or is continuously on. (default 16 hours)

Enable the function, as follows:

1. Press *Set* until  flashes, confirm with *Set*.
2. Press the right arrow until *FiPL* (Fire Place Function) appears in the display, confirm with *Set*.
3. Select *ON/OFF* using the right/left arrow, confirm with *Set*.
4. *16 h* (16 hours) flashes in the display. Adjust with the right/left arrow, where needed. Confirm with *Set*.
5. *50 %* (controlled output) flashes in the display. Adjust with the right/left arrow, where needed. Confirm with *Set*.

When the feature is enabled, the display will switch mode between normal view in order to subsequently display *HEAT*, *ON*, remaining time or *CON* for continuous and current heat effect in percent. When the fireplace function is enabled, the display switches between showing normal mode, hours remaining (e.g. 16 h), and controlled output (e.g. 50 %). When the set time has counted down to zero, the room thermostat returns to normal operation.

An enabled fire place function overrides any potential week program. Enabled setback or activated holiday function overrides the fire place function.

By-pass function

The By-pass function is primarily designed for use when the heat source comes from a heat pump. The function means that one (or more) room thermostats forces open its circuit by force when the other room thermostats close their circuits. Depending on the required function, you can either choose time-controlled bypass or a bypass that is constantly activated until some other circuit opens.



Time-controlled bypass keeps the bypass circuit open for 22 minutes, then turns the circuit off.

The By-pass function is enabled as follows:

1. Press *Set* until  flashes, confirm with *Set*.
2. Press the right arrow until *BYPS* (Bypass) appears in the display, confirm with *Set*.
3. Select ON using the right arrow, confirm with *Set*. ON and the clock symbol flash in the display indicating that the time-controlled bypass has been selected. Press the right arrow if a constant bypass is required. The clock symbol will disappear indicating that a constant bypass has been selected.
4. Confirm the selected function with *Set*.

Temperature range limits

It is possible to limit the room thermostats' adjustable temperature range. This function is useful in blocks of flats, for example, where landlords wish to restrict the ability of residents to control the room temperature within a certain temperature range, such as 18-22 °C. If you attempt to change the temperature outside the set temperature range, the room thermostat shows Min. and Max. values.

The function is enabled, as follows:

1. Press *Set* until  flashes, confirm with *Set*.
2. Press the right arrow until *RATR* (Restricted allowed temperature range) appears in the display, confirm with *Set*.
3. The lowest temperature in the temperature range flashes, set the required minimum temperature using the right/left arrow, *Set*.
4. The highest temperature in the temperature range flashes, set the required maximum temperature using the right/left arrow, confirm with *Set*. The display returns to show *RATR*.
5. Repeat the above for the other room thermostats that are to have a restricted temperature range.

External sensor – connection of remote sensor

The room thermostats can be fitted with remote sensor, for example, by controlling based on the temperature from the floor. If necessary, the remote sensor can be connected by extension cable up to 50 metres. For extension purposes, use the same cable area as the sensor or larger.

Note! Avoid routing in parallel with a high voltage installation, e.g. on a cable ladder.

The external sensor, LK External Sensor ICS/S2 is connected as follows:

1. The external sensor is to be installed in a protective pipe, see separate instructions in the *Remote sensor - location in different underfloor heating systems*.
2. Connect the sensor to the terminal block on the back plate of the room thermostat, the terminal is marked EXT. SENSOR.
3. Select the function the sensor is supposed to have, follow the instructions under the heading *Remote sensors - select function*.

Remote sensors - select function

You can specify a function to apply to the room thermostat when the remote sensor is connected.

Make the adjustment as follows:

1. Press *Set* until  flashes, confirm with *Set*.
2. Press the right arrow until *SENM* (Sensor Mode) appears in the display, confirm with *Set*.
3. The display's symbol to the left flashes.

Select from the following operating modes:

Only thermometer flashing = room temperature only. Confirm with *Set*. The external sensor is inactive.



Thermometer and MAX flashing = room temperature with the floor as maximum limit. Confirm with *Set*, the unit switches to flash MAX and the set maximum temperature. Set the maximum temperature using the right/left arrow, confirm with *Set*.



Thermometer and MAX flashing = room temperature with the floor at maximum limit. Confirm with *Set*, the unit switches to flash MAX and the set maximum temperature. Set the minimum temperature using the right/left arrow, confirm with *Set*.



Floor symbol flashing = floor temperature only, no effect from the room sensor. Confirm with *Set*. The internal sensor is inactive.



Resistance table, LK External Sensor ICS.2

Temperature	Resistance $k\Omega \pm 5\%$
0 °C	32.66
5 °C	25.40
10 °C	19.90
15 °C	15.71
20 °C	12.49
25 °C	10.00
30 °C	8.05
35 °C	6.53
40 °C	5.32

Remote sensor placement in different under-floor heating systems

Embedding in concrete

Before applying the concrete or screed, a conduit is positioned approximately 2 metres into the room. The end of the conduit must terminate centrally between two floor heating pipes. Seal the end of the conduit with tape or similar so that concrete cannot enter it. Try to position the conduit as high as possible in the structure, as this will result in a more representative performance when controlling the floor surface temperature. Insert the remote sensor in the conduit before applying concrete or screed and connect to the thermostat as described above.

LK HeatFloor 22, LK EPS 30/50/70 or LK Silencio

Cut a slot in the upper side of the slotted board, do not cross the floor heating pipes. Position a conduit in the cut slot, terminate the conduit centrally between two heat distribution plates. Insert the remote sensor in the conduit before laying the floor and connect to the thermostat as described above.

Underfloor heating in secondary spaced boarding
Position a conduit between two heat distribution plates and secure the conduit in the edge of the secondary spaced boarding using conduit clamps. Insert the remote sensor in the conduit before laying the floor and connect to the thermostat as described above.

LK EPS 16

Position a conduit along the long side of the floor heating installation so that it is pointing towards the nearest short side. At the short side cut a jack approximately 1 metres long in the EPS board measured from the short side. Insert the remote sensor in the conduit before laying the floor and connect to the thermostat as described above.

LK Clip Rail 8/LK Clip Rail 12

Position a conduit along the long side of the floor heating installation so that it is pointing towards the nearest short side. At the short side, route the conduit in the centre between two floor heating pipes and connect as approximately 1 metres in. Seal the end of the conduit with tape or similar so that concrete/flooring compound cannot enter it. Insert the remote sensor in the conduit before applying concrete or screed and connect to the thermostat as described above.

BATTERY REPLACEMENT

LK Room Thermostat RF ICS.2 comes with three 1.5V batteries LR03 (AAA). The batteries have a life expectancy of about two years. However, the life expectancy is affected by the user's selections, such as enabled backlight. The room thermostat display has a battery icon showing the status of the battery. The battery should be replaced when the icon is only showing one segment to the right of the icon.

Change the battery as follows:

Remove the room thermostat from the wall by gently pushing the locking tab with a screwdriver while you detach the room thermostat from the back plate. (The locking tab is positioned on the underside of the room thermostat.) Replace the batteries and snap the room thermostat in place again. After completing the battery replacement, the room thermostat automatically returns to normal operation after a short synchronisation.

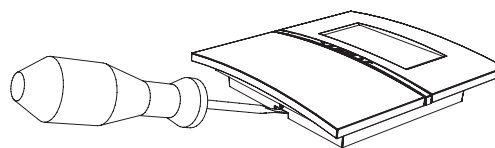

SYSTEM RESTRICTIONS

Below is a summary of system restrictions which should not be exceeded.

Restriction	Min	Max	Note
Number of room thermostats per receiver 8 ICS.2	1	8	
Number of actuators per Receiver unit 8 ICS.2	1	12	
Number of room thermostat per Receiver unit 1 ICS.2	1	1	
Number of actuators per Receiver unit 1 ICS.2	1	5	
Number of actuators per channel	1	3	Physically it is possible to connect two per connector.
Number of Receiver units ICS.2 per system	1	8	When the receivers are connected in a wireless network.
Number of channels per system	1	64	When the receivers are connected in a wireless network.
Maximum cable length for antenna (cable type: modular cable RJ10)	-	30 m	The LK Antenna cable is 10 m.
Max cable length with Modbus connection	-	75 m	RS-485 (3x0.5 mm ²)
Maximum cable length when connecting LK Webserver	-	75 m	3x0.5 mm ²

TROUBLESHOOTING/RESETTING

Typically, a floor heating system from LK is very reliable. However, as with any other equipment, issues may arise that make it necessary to troubleshoot or reset all or part of the system.

Basic troubleshooting for the Room Thermostat

If a fault occurs, the room thermostat display shows Err while an error code is displayed. The meaning and possible measures are read from can be found in the error code table.

If the display is “blank”, check the batteries and the power supply.

NOTE!

Completely trouble-free operation cannot always be guaranteed with the wireless technology available in the licence-free frequency band. Each installation should therefore be tested individually for interference in the surroundings.

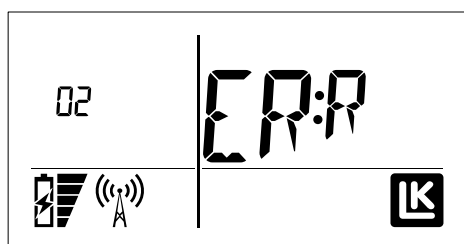

Resetting individual room thermostats

If necessary, a single room thermostat can be deleted from its receiver. Other room thermostats in the system remain unaffected. After deleting a room thermostat, all information about the individual zone disappears from the receiver unit and it is possible to add a new room thermostat to the deleted channel.

Follow the instructions below for resetting individual room thermostats:

1. Simultaneously press the left/right arrows until the display shows DEFA. (Do not press so that all three buttons gets press in, as that controls the button lock function).
2. Confirm immediately the reset by pressing the SET button once. If the display then shows Wait you need to wait a few seconds until Wait disappears. If Wait remains, press the left/right arrow simultaneously to force a reset.
3. After completing the reset, the room thermostat will show RUR (room unit radio) or, Alternatively, RUW (room unit wired) and can now be re-programmed.

If the room thermostat is missing or unusable for some other reason, then the room thermostat can be deleted via its receiver. One requirement is that you know which channel the unusable/missing room thermostat regulated.



Follow the instructions below to erase individual room thermostats directly from its receiver:

1. Hold in the L button on the receiver belonging to the room thermostat for three seconds.
2. The L light turns green and programmed channels turn orange.
3. During three seconds, press and hold the button for the channel* that the missing/unusable room thermostat controls. When the channels light goes out, the channel has been erased and can be reprogrammed.
4. Exit by pressing the L button once. Ensure that the L light goes out.

*If the missing/unusable thermostat controls more than one channel then lights will also be extinguished for these channels.

Basic troubleshooting for the Receiver

If a fault on the receiver occurs, this is shown by the unit's LED, which will turn red. The meaning and possible measures are found in the error code table. Always make sure the receiver is connected to a powered outlet. Also make sure the receiver's internal fuse is intact. The fuse is located under the high voltage cover.



NOTE! Cut all incoming power to the unit before opening the mains voltage cover. Remember that the relay for pump and heat source are powered from an external power supply which must also be cut.

Complete reset of the Receiver

A receiver can be reset, if necessary, to factory settings. Note that a reset of the receiver means that all the room thermostats that are connected/programmed to the unit also must be reset.

Things to consider: A system that consists of multiple receivers in a common network is affected if a unit is deleted/reset. The network can stop working if a unit is deleted.

Following a reset, the receiver can be re-programmed to the network.

Note: If the reset unit was a Master unit in the network, all Slave units and all room thermostats in the system must be reset and re-programmed.

To reset the 8-channel receiver unit, press and hold the A button and the channel 8 button simultaneously until all channel lights turn red. The unit is now reset.

To reset the 1-channel receiver unit, press and hold the A button and the channel 1 button.

Resetting the log files.

If you want to erase previous log files after, e.g. a change in the system, you can do this simply by pressing the A button and the channel 6 button.

The reset is carried out without confirmation. The function is available from software version 2.00

CHECKING THE WIRELESS NETWORK BETWEEN RECEIVER UNITS

Network control between receiver units can be performed from the LK Receiver Unit 8 ICS.2 that is installed as a master. LK Receiver Unit 1 ICS.2 should not be used as a master in a network, since it does not have lamps to indicate the status of the connected devices.

Press and hold in the A and L buttons. If the receiver unit has been programmed before, the L-light is green and the other channel's lights show the network's structure as below. Depending on the software version of the LK Receiver 8, the signal strength can be displayed, which is initiated when 1-8 flashes red.

Red: Shows the relevant unit's order number in the network.

Orange: Shows the number of units programmed in the network.

Green: Shows a free place in the network.

Example:

A network must be checked. The unit that is being checked displays a red light on channel 2 and an orange light on channels 1 and 3 as well as a green light on channels 4 to 8.



The network in the example above consists of a total of three programmed receiver units, one of which is the Master. The unit that has been checked has order number 2 in the network. The network can be extended with five receivers to a total of 8 units.

A Quick Guide for reset is available on www.lksystems.se, where you will find step-by-step instructions for resetting LK ICS.2.

CHECKING SIGNAL STRENGTH BETWEEN RECEIVER UNITS

From program version 2.00, signal quality between receivers in the wireless network can be checked from the Master.

Press and hold the A and L button of the receiver unit that is programmed as Master. The sequence will be initiated by 1-8 flashing red after 15 seconds. One of the figures 2-8 will then alternate between flashing red/green to indicate which receiver is analysed in the network.

The signal strength in the next step rises from 1 to 8 and ends with green indication at the level that corresponds to signal strength:

- 1 = No contact
- 2 = Poor connection
- 3...7 = Gradually better
- 8 = Full signal strength

In this mode, it is possible to reposition the antennas in order to optimise signal strength between receivers.

Remember that it takes a couple of minutes until the signal strength has stabilised after any change. The same applies if the receiver has been without power and has been started recently.

Complete the function by pressing the L button.



TABLE OF ERROR CODES

RU = RECEIVER UNIT RT = ROOM THERMOSTAT

Error code	RT indicates	RU indicates	Description	Things to do	Comment
1	01 ERR	Red light on the affected channel light	No communication has taken place in 60 minutes	Check the signal path, antennas and contacts. The distance may be too long.	
2	02 ERR	Red light on The L light for RU	No communication between RU - RU	Check the signal path, antennas and contacts. The distance may be too long.	RU sends error code to all RTs
3	Icon for radio mast flashing	-	No RU within radio range for the RT	Check the signal path, antennas and contacts. The distance may be too long.	RT tries to send error to RU
4	04 ERR,alt. 98 ERR	Red light on RU L light	Dual network ID	Reset all RU and RT. Redo all setup from start with error code.	Another RU has the same network ID
5	-	Red light flashes 3x on RU L light	RU cannot enter setup mode	Exit setup mode on another RU	Another RU is in setup mode
6	06 ERR	-	Wireless RT setup error	Press SET	Check the steps for setup
7	07 ERR	-	Wireless RT setup error	Press SET	Another RT is in setup mode with the RU
8	08 ERR	-	Wireless RT setup error	Press SET	RU is not set in setup mode
9	09 ERR	Red light flashing for current channel.	Actuator shortcircuit	Reset the error code by cutting power supply. Check the actuator if error recurs.	RU sends error code to RT
10	10 ERR	Red light on RU L light	Total current for actuator outputs too high	Error occurs when too many actuators is connected, either per output or total for entire RU. Check the number of actuators. Reset the error code by cutting the power supply	RU sends error code to RT
11	11 ERR	Red light flashing for the affected channel.	Actuator disconnected	Check the connection to the actuator	RU sends error code to RT
12	12 ERR	Red light flashing for the affected channel.	Actuator overloaded	Check connected actuator	RU sends error code to RT
13	13 ERR	Red light for the affected channel.	Thermostat error	Reset RT. Note: Error code indicated if possible.	-
14	14 ERR	Red light for the affected channel.	Error in room sensor	Check the sensor's connection	RT sends error code to RU
15	15 ERR	Red light for the affected channel.	Error in room sensor	Contact LK	RT sends error code to RU
16	Flashing battery icon	Red light for the affected channel.	Low battery level	Replace batteries.	RT sends error code to RU
17	17 ERR	Red light on U light	Login error		RU sends error code to RT
18	-	Red light on U light	Error in USB connection	Remove and reinsert LK ICS MEM Stick. If the problem persists, test another stick.	Applies to logging to LK ICS MEM Stick.
19	-	Red light on RU L light	RU setup error	Press the L button to return to the starting position.	RU was not programmed as Master or Slave. Cannot communicate with Master when set to setup mode.
20	20 ERR	-	Simultaneous setup of several wireless RT	Wait a couple of minutes and try again.	Another RT is being set up at the same time
21	21 ERR	-	Wired RT incorrectly connected to EXT	Check the connection behind RT. It should be connected to the ICS BOX contact.	The error code is only shown on the incorrectly connected RT



OVERVIEW OF ITEMS

Art. no.	Name	Notes
243 46 20	LK Room Thermostat 1 ICS.2 (NC) High-gloss white	Wireless communication
243 46 18	LK Room Thermostat RF ICS.2 High-gloss black	Wireless communication
243 46 19	LK Room Thermostat RF ICS.2 Silver grey	Wireless communication
243 46 21	LK Room Thermostat W ICS.2 High-gloss white	Wired communication
243 46 22	LK Room Thermostat W ICS.2 High-gloss black	Wired communication
243 46 23	LK Room Thermostat W ICS.2 Silver grey	Wired communication
243 46 24	LK Receiver 8 ICS.2 (NO)	Designed for normally open (NO) actuators.
243 46 25	LK Receiver 8 ICS.2 (NC)	Designed for normally closed (NC) actuators.
243 46 26	LK Receiver 1 ICS.2 (NO)	Designed for normally open (NO) actuators.
243 46 27	LK Receiver 1 ICS.2 (NC)	Designed for normally closed (NC) actuators.
241 73 23	LK External Sensor ICS.2/S2	Length 3 m
243 46 28	LK Antenna ICS.2	Spare part
241 73 24	LK Antenna Cable ICS.2	Length 10 m
33620	LK ICS.2 MEM Stick.	

TECHNICAL DATA

Article name	LK Room Thermostat RF ICS.2
Setting range	7 - 40 °C
Supply voltage	3 x 1,5 V AAA
Battery life	Ca: 2 years
Control function	Self-modulation technique
Measuring accuracy	± 0.2 °C
Dimensions	100 x 100 x 20 mm
Cable Protection class	IP20
Working temperature	+1 – +50 °C
Storage temperature	-20 – +70 °C
Maximum humidity during storage	No condensation
Radio frequency	868.30 MHz
Maximum radio frequency power	5 dBm

Article name	LK Room Thermostat W ICS.2
Setting range	7 - 40 °C
Supply voltage	5 V
Control function	Self-modulation technique

Measuring accuracy	± 0.2 °C
Dimensions	100 x 100 x 20 mm
Cable Protection class	IP20
Working temperature	+1 – +50 °C
Storage temperature	-20 – +70 °C
Maximum humidity during storage	No condensation

Article name	LK Receiver 1 ICS.2
Supply voltage	230 V AC
Control function	Self-modulation technique
Max number of actuators per channel	3
Max number of actuators per receiver	5
Dimensions	130 x 120 x 60 mm
Cable Protection class	IP30
Working temperature	+1 – +50 °C
Storage temperature	-20 – +70 °C
Maximum humidity during storage	No condensation
Radio frequency	868.30 MHz
Maximum radio frequency power	5 dBm

Article name	LK Receiver 8 ICS.2
Supply voltage	230 V AC
Control function	Self-modulation technique
Max number of actuators per channel	3
Max number of actuators per receiver	12
Dimensions	400 x 120 x 60 mm
Cable Protection class	IP30
Working temperature	+1 – +50 °C
Storage temperature	-20 – +70 °C
Maximum humidity during storage	No condensation
Radio frequency	868.30 MHz
Maximum radio frequency power	5 dBm

LK Systems AB hereby assures that LK Room Control ICS.2 complies with EU and R&TTE Directive 2014/53/EU. The complete EU declaration is available at: www.lksystems.se/globalassets/inriver-documents/lk-systems-se/technical-documentation/eu-declaration-of-conformity.pdf

ENERGY DECLARATION

Energy declaration in accordance with EU 811/2013

Temperature regulator's class	IV
Temperature regulator's contribution to the season's mean efficiency of room heating	2%

